

“DO IT YOURSELF”

MD5 MD7 MD11 MD17
S-drive & Inboard

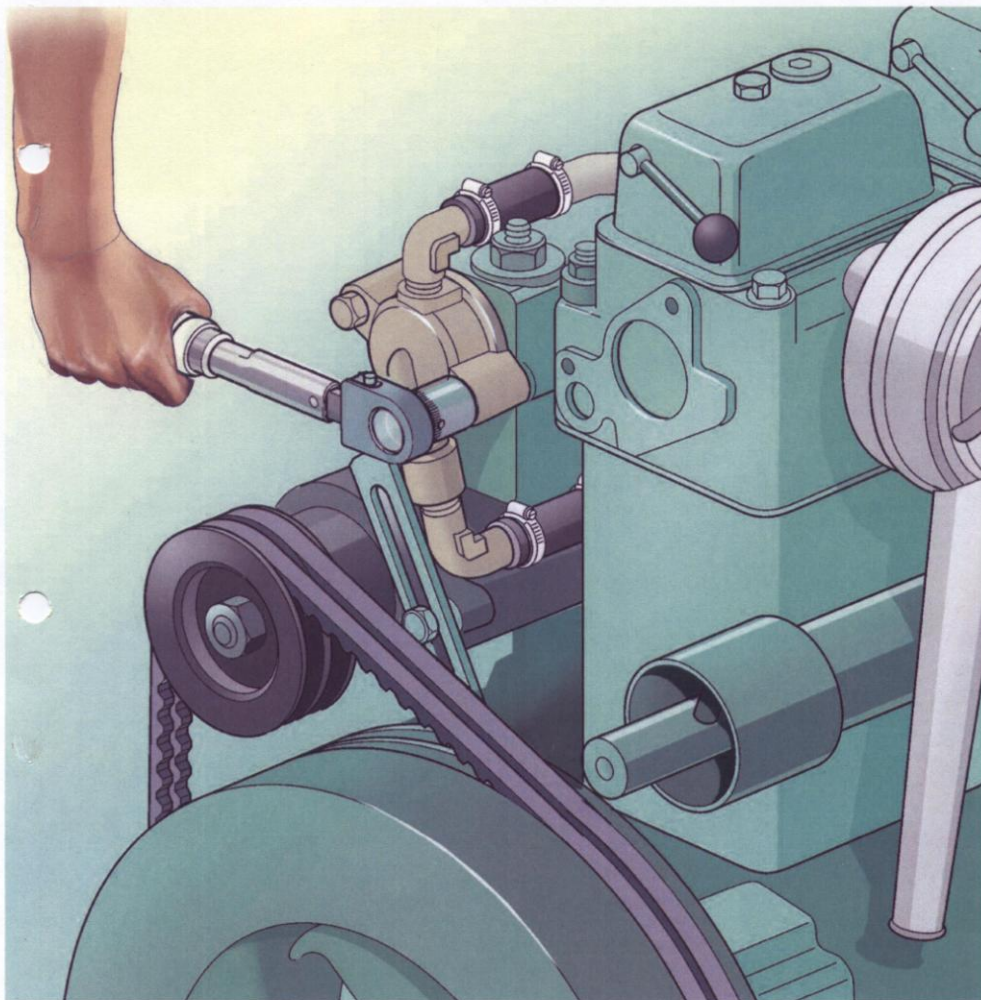

© 2007 AB VOLVO PENTA
All rights reserved.
Printed on environmentally friendly paper.

**VOLVO
PENTA**

“Do it yourself”

Marine engines

MD5 • MD7 • MD11 • MD17

Contents

Introduction	2	Wiring schedule, MD7	42
Important	2	Wiring schedule, MD11, MD17	43
Spare parts	2	Conservation	44
Environment	3	General	44
Thank you	3	Laying up, preparations	44
The Flen Factory	3	Oil change, engine and reversing gear	44
History – Engine Development	4	Fuel filter, change	45
Engine designations – Year of manufacture	5	Laying up	45
Design and function	5	Cleaning	46
Orientation, engine	6	S - drive	46
Technical data	10	Oil change	46
• Technical data MD5	10	Propellers	46
• Technical data MD7	11	Cooling system, seawater cooled engines	47
• Technical data MD11	12	Cooling system, fresh water cooled engines	48
• Technical data MD17	13	Impeller	49
Fault tracing	15	Vacuum valve	49
Cylinder head	16	Electrical system, cables	49
Cylinder head gasket, change	17	Batteries	50
Test tightening, cylinder head	20	• Other matters	50
Adjusting the valve clearance	21	• Engine bay	50
Cleaning the induction air silencer	22	• Propeller shaft seal	50
Lubrication system	23	• Controls	51
Engine, oil change	23	• Fuel tank	51
Oil filter change	24	• Rubber components	51
Sailboat drive, oil change	25	• Exhaust system	52
Reversing gear, oil change	25	• Folding propeller	52
Lubrication system	23	• Other special equipment	52
Engine, oil change	24	Removing conservation preparations	53
Oil filter, change	24	Removing covers	53
Fuel system	26	Boat hull	53
Feed pump	27	S - drive	53
Fuel filter, change	28	Protective anodes	54
Checking the secondary fuel filter	28	Engine and transmission	55
Venting the fuel system	29	Cooling system	55
Cleaning the fuel strainer	31	Vee belt	55
Changing the injectors	32	Exhaust system	56
Cooling system	33	Fuel system	56
Coolant hoses	33	Electrical system	56
Impeller, change	34	Launching	57
Renovating the coolant pump	35	Check list	57
Thermostat	36	Propeller shaft seal	57
Vacuum valve	37	Test driving	57
Electrical system	38	Volvo Penta's exchange system	58
General advice	38	Accessories, engine	59
Changing the fuse	39	Oils, paints and other accessories	61
Alternator belt	40	Notes	65
Wiring schedule, MD5	41		

Introduction

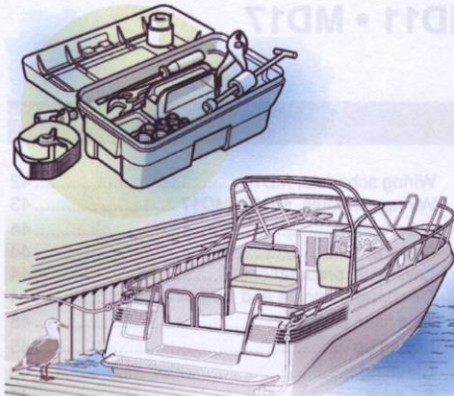

During the warranty time, it is important that an authorized Volvo Penta workshop should do any repair work, so that the warranty terms are not breached.

Important

The following special warning signs occur in the "Do it yourself" handbook and on the product.

WARNING!

Warns for the risk of personal injury, major damage to product or property, or serious malfunctions if the instruction is ignored.

IMPORTANT!

Is used to call attention to things which could cause damage or malfunctions to product or property.

NOTE!

Is used to call attention to important information, to facilitate work processes or operation.

Spare parts

Your Volvo Penta product, as with all other Volvo Penta products, has been designed to withstand a harsh marine environment and give long service life. All components have been designed and calculated to facilitate this together.

In order to maintain the optimum safety and service life built in, it is extremely important that you always choose Volvo Penta Original Spare Parts. You have invested a lot of money in your engine and transmission unit, and if correctly looked after it will retain a large part of its value if you should ever choose to sell your boat. Do not fall for the temptation to install "pirate" components. Components of unknown specification, which are said to fit your Volvo Penta, might be cheaper to buy, but nobody guarantees that they really have been tested, or comply with the material and quality requirements that Volvo Penta applies to marine engine components. Non-original spares can be a short-term investment that can lower the overall quality and safety. No chain is stronger than its weakest link. Volvo Penta's dealers all over the world are ready to help you with Volvo Penta Original Spares. Trained technicians can also give you good, specific advice about installation.

You can find more information at:

www.volvopenta.com

Many people prefer to maintain their boat and equipment themselves, since for many people a boat is not just something to ride in, it is also a pleasant leisure activity.

Security and safety aboard is very dependent on the condition of the boat's equipment. The most important link in the reliability chain is the engine and driveline. This handbook has been written as a "do-it-yourself" manual, with descriptions of the functions of each system, and their care and maintenance.

Tasks related to each maintenance point are described in great detail, with both text and illustrations. The tools needed are also specified, which offers the practical advantage that you can review the task theoretically at home. The tools needed for each task and any spare parts can be purchased in advance, before you travel out to your boat.

The tasks described are those which we believe that an boat owner of average practical ability should be able to do safely. Each one of us has a different level of knowledge and experience from professional life, education etc. For this reason, the level of difficulty of the operations described in this "Do it yourself" handbook may be perceived differently. If you feel at all unsure about any point, please ask your authorized Volvo Penta workshop for advice. The personnel will be happy to give you advice, and to undertake the tasks that you might need some help with.

Even if you are an experienced professional, all the more difficult tasks should be given to an authorized Volvo Penta workshop to do. These tasks often require access to special tools and workshop manuals to be done safely. Work on the injector pump and injectors should always be done by an authorized workshop, which has the special equipment and training needed.

Environment

All of us want a clean, healthy marine environment for relaxation and recreation. We, as all living things, depend on clean air, clean water and peace.

Unfortunately, the marine environment is under threat from many sources. The purity of the air and water, and the peace of the natural environment are all affected by human activity in and near to the water.

In our product development, we give priority to efforts to giving our products the smallest possible environmental impact. We constantly endeavor to reduce exhaust emissions, fuel consumption and noise levels.

It is you, the boat owner, who has the final say in how the environment is affected. Always run the engine with the recommended fuel and in the way suggested in the instruction book.

It is very important that the annual service work is done. Some of this work has to be done by authorized personnel.

In many of the tasks described, components have to be changed. Scrapped oil and fuel filters always contain a small amount of oil or fuel and must be deposited in the special bins found at service and recycling stations, together with other chemicals and used batteries. Volvo Penta recommends that you should use biodegradable degreasers and, if possible, mechanical hull cleaning instead of poisonous anti-fouling paints.

By responsible behavior as a boat owner and boat operator, you make do a very valuable contribution to conservation of our marine environment.

The Flen Factory

The Flen factory has roots going back to 1891, when it was founded as a saw mill. In 1912, the saw mill business was sold and the new owner started to make harvesting machinery. The company, Olléns Tröskmaskinfabrik, saw many changes of ownership until 1945 when Bolinder Munktell acquired a majority of the shares. At that time, Bolinder Munktell only made agricultural machinery and was the market leader for combine harvesters in Sweden. Their strongest competitor was Olléns. The intention was to coordinate and concentrate manufacture of combine harvesters to Flen, to improve competitiveness.

Bolinder Munktell was then acquired by Volvo in 1950, together with the Flen factory. Both under Bolinder Munktell and under BM Volvo, the factory was considerably extended, but the aims were changed in 1960 when BM Volvo acquired a competing combine harvester manufacturer, and all manufacture was concentrated to their factory site at Hallsberg. At this point, the Flen factory's era as a manufacturer of combine harvesters had ended, and Volvo decided that the Flen factory would renovate engines for all of Volvo's production companies. The factory was now transferred to the Volvo



Skövde works and also started in 1963 to make 1 and 2 cylinder engines for Volvo Penta. These had previously been made at Skövde, but this production was now transferred to Flen. The volumes of both renovation

and of Penta's marine engines grew strongly, and the factory site had to be extended several times. Volvo Penta had expanded strongly during the 1960s and was now Europe's largest marine engine manufacturer. The 28 January 1976 was a historic day, when the last MD2 engine was made. They succeeded in making a total of 31412 MD2 engines. The MD2, together with the MD1 and MD3 were replaced by the improved engines that this "Do-it-yourself" manual covers, which are the MD5, MD7, MD11 and MD17. For this reason, the manual is largely applicable to the previous MD6, MD2 and MD3 as well.

The last MD17 engine was made in 1984, but the newly-designed successors in the 2000 series also came to be made at Flen. In 1990, the Flen factory was transferred from Volvo Components to Volvo Penta, but a reduced total market for small marine diesels led Volvo Penta to decide in 1993 that the successor to the 2000 series would be based on purchased short block engines and completed with Volvo Penta's marinization by a sub-contractor. After 30 years as a marine engine manufacturer, the Flen works returned to concentrate on being the engine restorer for the Volvo Group. The marine engines which leave the Flen factory these days are exchange engines, which look the same and are comparable to newly made engines, but they already have a complete service life as an engine behind them.

Thank you

Volvo Penta announced their first marine engine in 1907. Quality, reliability and innovation have made Volvo Penta a world-leading marine engine manufacturer. However, no product is better than the care and service it gets. We have found, from our correspondence, that it is not unusual to find 20-30 year old Volvo Penta products that are still in as-new condition. This is thanks to our owners' conscientious care and maintenance. All of us at Volvo Penta are proud and grateful for all the attention this gives us. Of course, we hope that you will have many care-free years in the same way, with your Volvo Penta equipped boat.

We hope that you will have some pleasant "do-it-yourself" sessions, followed by many enjoyable boat trips.

AB VOLVO PENTA
Market communication

History – Engine Development

MD1, MD2, MD3, MD11, MD17

Volvo Penta announced the world's first light, direct-injected marine diesel engine, the MD1 in 1958. The 1-cylinder engine had a swept volume of 450 cc and gave 5 hp at 2000 rpm. In 1964, the two-cylinder MD2 was announced. This had two cylinders, twice the swept volume, and gave 15.5 hp at 2300 rpm. The engines enjoyed progressive product development, and were then given the generation letters A and B. In generation A, they were redesigned on the "building block system", so that the main components were common to all engines. In generation B, which was announced in 1970, the cylinder diameter was increased from 79.37 till 88.90 mm. This increased the swept volume to 560 cc and the power of the MD1B was 10 hp. The MD2B gave 25 hp. This was also the preparation for an increase in the engine family. In 1971, the 3-cylinder MD3B was announced. This gave the 3-cylinder engine 1680 cc and it developed 36 hp at 2500 rpm.

The engine became very successful, but Volvo Penta's engineers were not allowed to rest on their laurels, they were given new development goals. This was a market demand for more power, but also a demand for more compact engines for sailing boats, above all. This led to the development of the MD2B and MD3B. The new engines were announced in 1975.

The 2-cylinder engine was given the designation MD11C and the 3-cylinder was called MD17C. The new designation figure referred to the swept volume instead of the number of cylinders as previously. Among other things, the engines were given wet cylinder liners, a malleable iron crankshaft and the power increased. A curiosity; in 1967 they developed the LD1 and LD2 engines. These were air-cooled!! versions of the MD1 and MD2, intended for a customer in Thailand, as irrigation engines. The deal fell through and only two prototypes were made, one of which is in Volvo Penta's museum collection.

MD5

The 1-cylinder MD1B had relatively large dimensions, for its power class, so they had decided to develop a new 1-cylinder engine with 45 degree inclination. When the design was finished, it turned out that the production costs for the planned volume would be too high, so it was decided to shelve the design. In 1974, Volvo Penta found a manufacturing partner in Norway, Mandals Motorfabrik, and the new MD5A engine could be sub-contracted to them. The engine was further developed to the MD5B in 1978 and the MD5C in 1981.

MD6-MD7

Volvo Penta acquired Albin Motor's diesel engine business in 1974, including a recently developed engine which was given the Volvo Penta designation MD6A. The engine did not have a full-flow filter, and was equipped with a Dynastart. For this reason, further development gave it a full-flow oil filter, starter motor and an alternator. The MD6B started production in 1975. The demand for higher power led to an increase in cylinder diameter from 70 to 76 mm and the cylinder head was given larger inlet and exhaust valves. The swept volume of the engine now increased from 631 cc to 744 cc, and the power increased to 13.6 hp at 2600 rpm. The new engine was given the designation MD7A, and was announced in 1976. Power output was increased to 17.5 hp at 3.000 rpm by increased engine speed etc. in the MD7B which was announced in 1981.

Engine designations – Year of manufacture

Designation	Year	Characteristics, notes	Cyl. Ø / stroke (mm)	Power (hp/rpm)	As from engine no.
MD1	1958-1960	Designed in inches, 35° injector angle.	79.37/90	5.0/2000	100
MD1	1960-1962		..	5.5/6.0/2000	1095
MD1	1962-1963	Designed in metric, 35° injector angle.	..	6.0/2000	4000
MD1	1963-1964	Injector sleeve Ø 14 mm	..	6.3/2000	
MD1A	1964-1970	20° injector angle, injector sleeve Ø 14 mm	..	7.0/2300	10000
	as from 1968	Gear wheel lube oil pump	16218
	as from 1969	Heinzman regulator	16326
MD1B	1970-1976	Dynastart	88.9/90.0	10.0/2500	18000
MD2A	1964-1967	20° injector angle, injector sleeve Ø 14 mm	79.37/90	15.5/2300	100
	1967-1970		..	16.5/2300	7263
	as from 1968	Gear wheel lube oil pump	7362
	as from 1969	Heinzman regulator	8033
MD2B	1970-1975	Dynastart or starter motor + alternator	88.9/90.0	23.0/2500	10500
MD3B	1971-1975	Starter motor + alternator	..	35.0/2500	100
MD5A	1974-1978	Cylinder angle 45°	84.0/80.0	7.5/2500	100
MD5B	1978-1981	Modified engine brackets etc.	15000
MD5C	1981-1982	MB21 Oil pump, malleable iron crankshaft	..	9.5/3000	30000
MD6A	1971-1975	Dynastart	70.0/82.0	10.0/2400	100
MD6B	1975-1976	Starter motor + alternator, full flow filter	8000
MD7A	1976-1981	Starter motor + alternator	76.0/82.0	13.5/2600	10975
MD7B	1981-1983		..	17.5/3000	32550
MD11C	1975-1981	Wet cylinder liners, malleable iron crankshaft	88.9/90.0	24/2500	33000
MD11D	1981-1983		..	25.0/3000	55700
MD17C	1975-1981	Wet cylinder liners, malleable iron crankshaft	..	35/2500	9000
MD17D	1981-1984		..	36/3000	18400

Design and function**Engine, general**

The engines are in-line 1, 2, 3 or 4 cylinder, 4-cycle directly injected diesel engines with overhead valves. The valves are operated by rocker arm mechanisms, push rods and valve lifters. The camshaft is driven by the crankshaft, via timing gear wheels. The engine block and cylinder head are manufactured of alloyed cast iron. The MD11 and MD17 have loose engine blocks, one for each cylinder. The blocks are held in place by the cylinder head, which is fixed by long studs from the crankcase. The MD5 and MD7 have the engine block and crankcase cast in one unit. The MD5, MD11 and MD17 have replaceable, wet cylinder liners. The MD7 has its cylinder bore drilled directly through the block.

Engine lubrication is provided by a pressure lubrication system which uses an efficient, gearwheel pump to pump the oil out through a reduction valve and oil filter to the lubrication points. The oil filter is a full-flow filter.

The cooling system is a thermostatically controlled seawater system. A fresh water system is available as an optional extra.

The fresh water system (optional) is thermostatically controlled and cools the engine block and cylinder head. Sea water cools the fresh water system via a heat exchanger.

The fuel system consists of a feed pump, fuel filter, injector pump, fuel supply pipes and injectors. The injectors are mounted in the cylinder head, inside copper injector sleeves which are surrounded by cooling water.

The exhaust system consists of a seawater cooled, cast iron exhaust pipe and manifold, with a pipe stub for attaching a hose to the hull fitting.

Electrical system, 12 V with alternator. Please refer to "Technical Data" for a detailed specification.

MD7A

1. Oil dipstick and oil filling, reverse gear
2. Cover, sea water pump
3. Bleed-screw, fine filter
4. Fine filter
5. Decompression lever
6. Pressure pipe nut
7. Temperature sender
8. Injector
9. Thermostat housing
10. Oil filling, engine
11. Hand start
12. Cooling water drain, engine
13. Fuel injection pump
14. Oil dip-stick, engine
15. Cooling water drain, reverse gear
16. Air cleaner and intake silencer
17. Sender, rev counter
18. Fuel pump (with hand pump)
19. Cooling water inlet, reverse gear
20. Switch, oil pressure
22. Oil filter

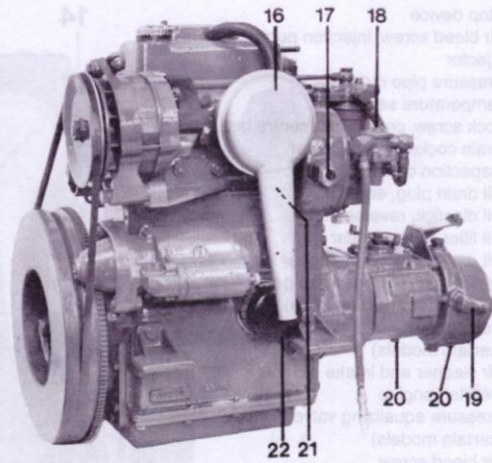
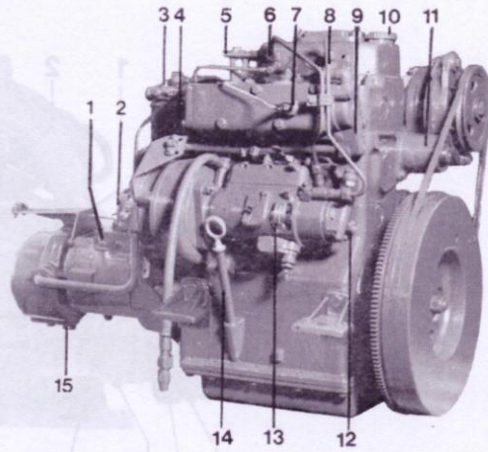

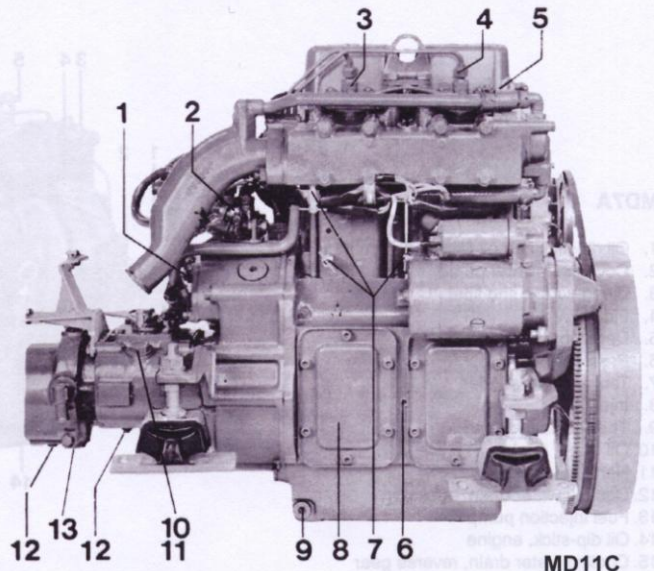

MD11C

MD11C, MD11D

1. Stop device
2. Air bleed screw, injection pump
3. Injector
4. Pressure pipe nut
5. Temperature sender
6. Lock screw, crank shaft centre bearing
7. Drain cocks, cooling water
8. Inspection cover
9. Oil drain plug, engine
10. Oil dipstick, reverse gear
11. Oil filler, reverse gear
12. Oil drain plug, reverse gear
13. Water drain plug, reverse gear (MD11D connection hose)
14. Decompression lever (certain models)
15. Air cleaner and intake silencer
16. Oil filler, engine
17. Pressure equalizing valve (certain models)
18. Air bleed screw
19. Fine filter
20. Feed pump
21. Sender rev. counter
22. Oil filter
23. Oil pressure sender
24. Oil strainer and oil dipstick (MD11C)
25. Oil dipstick (MD11D)

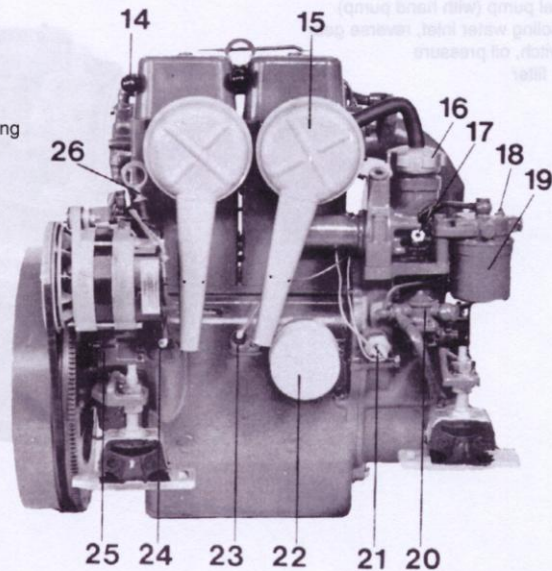

MD11D

MD17C, MD17D

1. Fuse box
2. Decompression lever (certain models)
3. Air cleaner
4. Oil filler
5. Air bleed screw
6. Fine filter
7. Feed pump
8. Sender rev counter
9. Oil filter
10. Stop device
11. Adjustment screw, high idle
12. Adjustment screw, low idle
13. Leak-off pipe
14. Lifting eye
15. Pressue pipe
16. Injector
17. Thermostat housing
18. Oil dipstick
19. Drain cocks, cooling water
20. Engine type & number plate
21. Cooling water pump

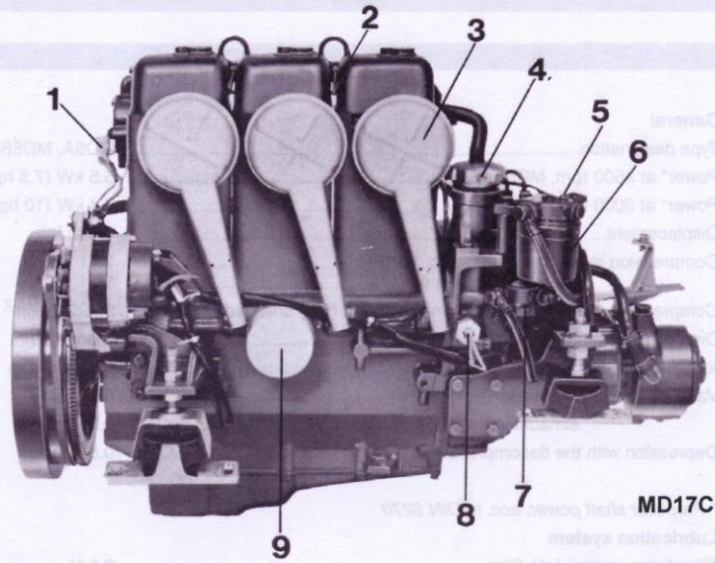

MD17C

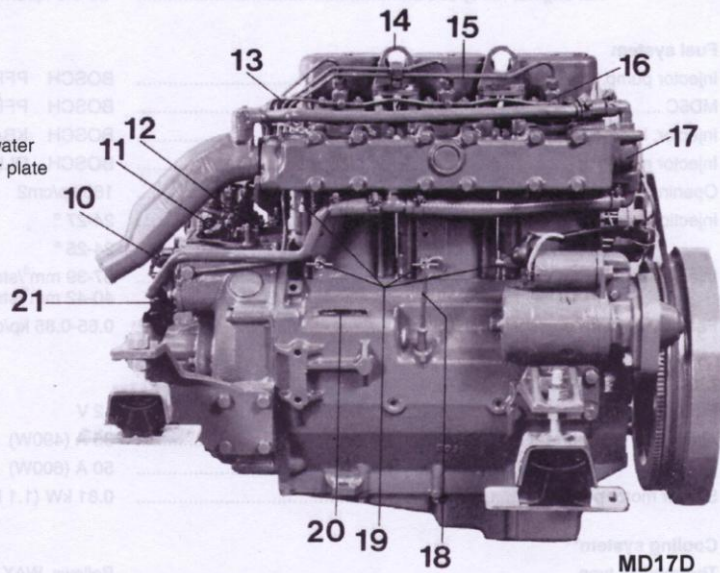

MD17D

Technical data

MD5

General

Type designation.....	MD5A, MD5B, MD5C
Power* at 2500 rpm, MD5A, B.....	5.5 kW (7.5 hp)
Power* at 3000 rpm, MD5C.....	7.4 kW (10 hp)
Displacement.....	0.443 L
Compression ratio, up to engine no. 1719.....	15:1
as from engine no. 1720.....	16:1
Compression pressure at starter motor speed (fully charged battery) ...	20-22 kp/cm ²
Direction of rotation, seen from flywheel.....	Clockwise
Idling speed.....	700-800 rpm
Valve clearance, inlet valve (hot engine).....	0.30 mm
exhaust valve (hot engine).....	0.35 mm
Depression with the decompressor device (not adjustable on MD5C)...	0.5 mm

* Propeller shaft power, acc. to DIN 6270

Lubrication system

Oil volume, engine incl. filter.....	2.1 L
Oil grade to: API.....	15W/40 CD
Oil pressure, hot engine, idling speed.....	1.5-2.5 kp/cm ²
hot engine, full speed.....	4.0-5.0 kp/cm ²

Fuel system

Injector pump, MD5A, B.....	BOSCH PFR 1K 70A/431/11
MD5C.....	BOSCH PFEIQ70V13955
Injector, holder.....	BOSCH KBAL 65
Injector nozzle.....	BOSCH DLLA150
Opening pressure, new injector.....	185 kp/cm ²
Injection advance, MD5A, B.....	24-27 °
MD5C.....	24-25 °
Injected volume, MD5A, B.....	37-39 mm ³ /stroke at 40 °C, 1000 rpm
MD5C.....	40-42 mm ³ /stroke at 40 °C, 1000 rpm
Feed pump, feed pressure at 2500 rpm.....	0.65-0.85 kp/cm ²

Electrical system

Battery voltage.....	12 V
Alternator, max current density (power) MD5A, B.....	35 A (490W)
MD5C.....	50 A (600W)
Starter motor power.....	0.81 kW (1.1 hp)

Cooling system**

Thermostat, type.....	Bellows, WAX as from engine no. 18374
Starts to open at.....	60°C ± 2°
Fully open at.....	75°C

** Std. sea-water cooled

Technical data

Cooling system**

Thermostat, type	Bellows thermostat
Starts to open at	60°C ± 2°
Fully open at	75°C

** Std. sea-water cooled

Torque

Cylinder head nuts ***	70 Nm
Cylinder head studs.....	20 Nm
Nut for injector yoke.....	8 Nm
Screw for starter motor	70 Nm
Screw for engine brackets, front and rear.....	45 Nm

*** Tightening in three stages

- 1:st stage: 10 Nm
- 2:nd stage: 40 Nm
- 3:rd stage: 70 Nm

MD11

General

Type designation.....	MD11C, MD11D
Power* at 2500 rpm, MD11C.....	17 kW (23 hp)
Power* at 3000 rpm, MD11D.....	18.4 kW (25 hp)
Displacement.....	1.12 L
Compression ratio	17.5:1
Compression pressure at starter motor speed (fully charged battery)	20-25 kp/cm ²
Direction of rotation, seen from flywheel	Clockwise
Idling speed.	750-810 rpm

Valve clearance, inlet valve (hot engine)	0.30 mm
exhaust valve (hot engine)	0.35 mm
Decompression device, max. depression of exhaust valve (not adjustable on MD11D).....	0.5 mm

* Propeller shaft power, acc. to DIN 6270

Lubrication system

Oil volume, engine incl. filter.....	2.85 L
Engine with RB reversing gear, including filter	3.25 L
Oil grade to: API	15W/40 CD
Oil pressure, hot engine, idling speed	1.0-2.0 kp/cm ²
hot engine, full speed.....	2.0-3.0 kp/cm ²

Fuel system

Injection pump	BOSCH
Opening pressure, new injector, MD11C	170 kp/cm ² , -0, +8 kp/cm ²
new nozzle, MD11D	245 kp/cm ² , -0, +8 kp/cm ²
Injection advance, MD11C	24-26° BTDC
MD11D	24.5-26.5° BTDC
Injection volume (at 1000 rpm, pump speed)	35-36 mm ³ /stroke at 20°C
Feed pump, feed pressure at 2500 rpm	0.65-0.85 kp/cm ²

Electrical system

Battery voltage.....	12 V
Alternator, max current density (power), MD11C	35 A (490W)
max current density (power), MD11D	50 A (700W)
Starter motor power.....	1.1 kW (1.5 hp)

Cooling system**

Thermostat, type	Bellows thermostat (can be replaced by WAX)
type from motor no. 49685.....	WAX
Starts to open at	60°C ± 2°
Fully open at	74°C

** Std. sea-water cooled

Torque

Cylinder head nuts ***	110 Nm
Injectors	20 Nm
Top hat nuts, valve cover	15 Nm
Nipple for oil filter	40 Nm

*** Tightening in three stages

- 1:st stage: 30 Nm
- 2:nd stage: 80 Nm
- 3:rd stage: 110 Nm

MD17

General

Type designation.....	MD17C, MD17D
Power* at 2500 rpm, MD17C.....	26 kW (35 hp)
Power* at 3000 rpm, MD17D.....	26.5 kW (36 hp)
Displacement.....	1.68 L
Compression ratio	17.5:1
Compression pressure at starter motor speed (fully charged battery)	20-25 kp/cm ²
Direction of rotation, seen from flywheel	Clockwise
Idling speed.....	750-810 rpm
Valve clearance, inlet valve (hot engine)	0.30 mm
exhaust valve (hot engine).....	0.35 mm
Decompression device, max. depression of exhaust valve (not adjustable on MD17D).....	0.5 mm

* Propeller shaft power, acc. to DIN 6270

Fault tracing

Engine does not start (starter motor does not turn)

Check that the main switch is switched on and that the main fuse is intact. Check that the battery is not flat. If a disconnected battery loses charge or can not be charged, it has a short circuit and must be changed. Check that the battery and starter motor cables are securely fixed. If there is enough current in the battery and a clicking noise is heard from the starter motor solenoid when the starter key is turned, this indicates that the starter motor is faulty. If nothing is heard from the solenoid during the above test, the solenoid, starter switch contact or their electric cables are defective.

The engine does not start (starter motor turns) or the engine stops when running.

Check that the fuel tank is not empty. If a supplementary fuel filter is installed, there should be fuel in the glass bowl (where appropriate).

Check that fuel arrives at the injectors by undoing the fuel supply pipes from the injectors (please refer to changing injectors) and then crank the engine with the starter motor. If no fuel comes out, this could be caused by a blocked filter, a fault in the supply pump or air in the system. Change all filters and vent the system. If fuel still does not come out, the fault is probably in the fuel pump or injector pump.

On the other hand, if fuel does come out of the fuel supply pipes during the above test, an injector might be faulty. Change the injectors and try to start the engine. If the engine still does not start, the fault is probably in the injection pump. This must be attended to at a Volvo Penta workshop.

The engine runs unevenly or vibrates abnormally.

Most engine malfunctions are caused by the fuel system and are often caused by contamination, water or air in the system. For this reason, change all filters and vent the system. Then possibly try changing the injector(s). Check that all fuel unions seal correctly.

In rare cases, engine malfunctions are caused by loss of compression in one or more cylinders. For this reason, ask an authorized Volvo Penta workshop to do a compression test.

The engine becomes abnormally hot.

Engine overheating is caused by one or more of the following causes.

1. Faulty thermostat Please refer to "checking and changing the thermostat".
2. Faulty water pump Please refer to "Changing the impeller".
3. Blockage in the cooling water inlet or cooling jackets. Disassemble and clean.
4. Incorrect reading on temperature gauge (no other signs that the temperature is too high).

Engine does not reach full operating speed at full throttle.

If the engine starts well, and runs evenly but does not reach the operating speed it had previously, this might not be caused by any fault in the engine, it can also be caused by hull fouling or heavy loading. It could also be caused by some form of damage to the propeller, or a blocked air filter. If you can eliminate the above reasons, the reason could be a loss of compression in the engine. Ask an authorized Volvo Penta workshop to do a compression test. If the instrumentation has a tachometer, the tachometer might be defective, and not show the full engine speed.

The engine runs evenly but vibrates abnormally.

Damaged propeller or defective engine mounting pads. Faulty engine alignment (reversing gear engine). Once a season, or after launching, the engine alignment in relation to the propeller shaft should be checked and adjusted if necessary. Checking is done as follows:

Undo the screws for the propeller shaft flange. Use a 0.10 mm feeler gauge to check that it can not be slid between the reversing gear and propeller shaft flanges at any point, at the same time as the propeller shaft flange is pressed forwards. Turn the shaft 90°, 180° and 270° at the same time as the feeler gauge test is being done.

If the deviation is greater than 0.10 mm, the alignment must be adjusted. If an adjustable rubber mounting is not installed, the thickness of the underlying spacers must be changed.

Cylinder head

General

The engines (apart from the MD7) have separate cylinder heads for each cylinder. The MD7 has common cylinder head for both cylinders. In all service on the cylinder(s), apart from things that a "do-it-yourself" enthusiast can do, such as renovating the valve mechanism, the work must be done on all cylinders, even if the fault only shows up on one cylinder, such as leaky valves. It is extremely important during re-assembly, that the tightening schedule for the cylinder head screws is followed and that all tightening is done to the correct torque. A torque wrench is an essential tool!

The following components must be new when the cylinder head is installed:

	MD5	MD7	MD11	M17
Gasket, exhaust pipe elbow	859015	859015	859015	859015
Gasket, exhaust pipe - cylinder			859145	859145
Cylinder head gasket	859134	3809167	859137	859137
Valve cover gasket	838066	840115	859120	859120

The following tools are needed for the work below:

Changing the cylinder head gasket	MD5	MD7	MD11, MD17
Allen key	5, 6 mm		10 mm
Ring wrench	1/2", 7, 10 13, 15, 17 mm	10, 17 mm	10, 12, 13, 17 mm
Open end, fixed wrench	17, 18 mm	13 (3 pcs), 17 mm	17 mm
Socket	10, 15 mm	15 mm	13, 19 mm

Test tightening of the cylinder head

Torque wrench	1	1	1
Allen key	5, 6 mm		10 mm
Ring wrench	1/2", 10 mm	17 mm	12, 13, 17 mm
Open-end fixed wrench		13 mm (3 pcs)	
Socket	15 mm	15 mm	19 mm

Adjusting the valve clearance

Allen key	5 mm		10 mm
Ring wrench	1/2"	17 mm	13, 17mm
Open end, fixed wrench		13 mm (3 pcs)	

In addition to the tools above you will need screwdrivers with blade with 7 and 10 mm, a feeler gauge for valve adjustment and cleaning rags.

Cylinder head gasket, change

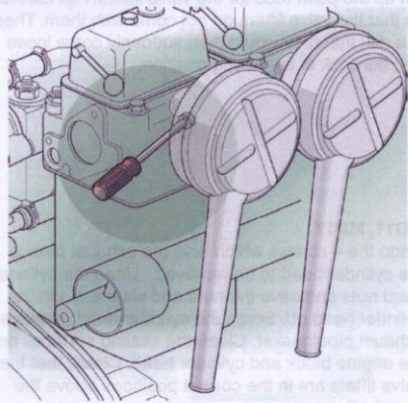

General.

Drain the cooling water from the engine. If the boat is in the water, the hull cock must be closed during this operation. The main switch must be in the "off" position. Work should start by carefully cleaning the engine, to prevent dirt from falling down into the cylinders and valve mechanism. Remove the induction silencer by undoing the screw on the clamp for the connection sleeve. At the same time, clean the induction silencer insert. Dip the entire induction silencer in diesel oil, shake it about, then let it drain off. Then dip the insert in thin engine oil and leave it to drain.

⚠ WARNING!

Be careful not to let water get in! Never leave the boat until you have ensured that the sea cock is closed and that water can not find its way in under any circumstances and sink the boat.

Remove the exhaust pipe elbow from the engine. Take the chance of checking the exhaust pipe elbow for corrosion damage and deposits. Clean if necessary: If possible, leave the exhaust hose behind on the elbow.

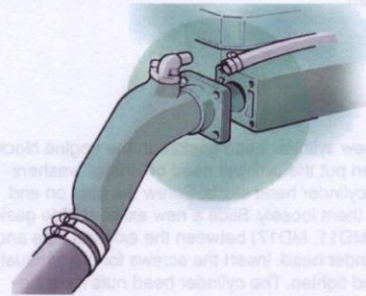

Undo the fuel supply pipes from the injectors. Any clamps on the fuel supply pipes must be removed.

⚠ IMPORTANT!

Be very careful to ensure that no dirt gets into the fuel system. Put protective covers over the openings of pipes and injectors.

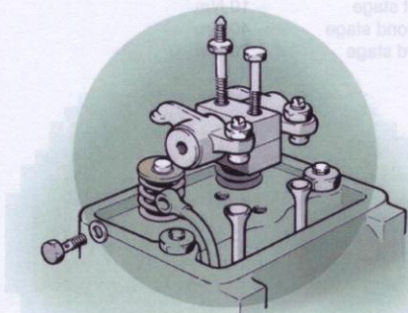
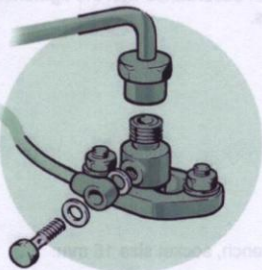

Pull the cable away from the temperature sensor (by the thermostat). Remove the valve cover. Then remove the valve bridge. On the MD11 and MD17, remove the oil pipe from the rocker arm shaft as well. Be careful to ensure that no screws or washers fall down into any of the holes in the cylinder head. Lift the valve bridge away.

Cylinder head

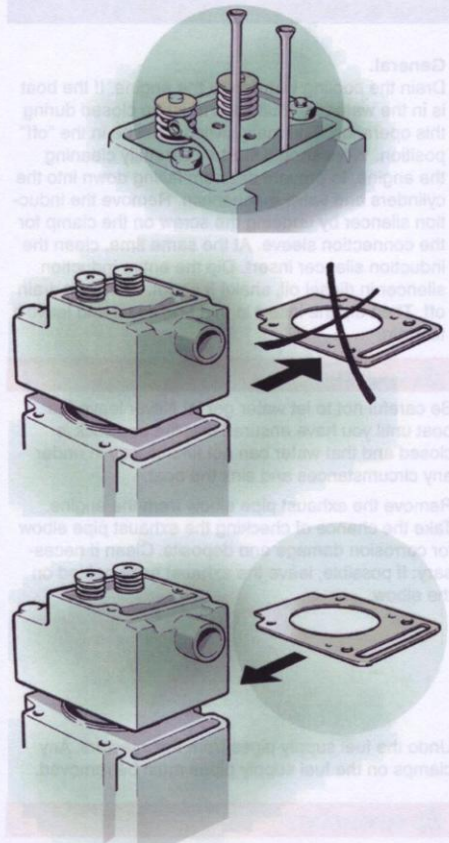

MD5, MD11, MD17

Lift up the push rods for the valve lifters. Pull carefully so that the valve lifters do not come with them. There is a risk that they would then suddenly come loose and fall back in the wrong position.

MD11, MD17

Undo the 4 screws which hold the exhaust pipe to the cylinder head to be removed. Undo the cylinder head nuts and save the nuts and washers. Lift the cylinder head off. Scrap the cylinder head gasket and exhaust pipe gasket. Clean the sealing surfaces on the engine block and cylinder head. Check that the valve lifters are in the correct positions above the camshaft.

Put a new cylinder head gasket on the engine block and then put the cylinder head on. Install washers for the cylinder head studs. Screw the nuts on and tighten them loosely. Slide a new exhaust pipe gasket down (MD11, MD17) between the exhaust pipe and the cylinder head. Insert the screws for the exhaust pipe and tighten. The cylinder head nuts must be tightened in accordance with the tightening schedule, in 3 stages.

MD5

← SVÄNGHJUL
FLYWHEEL

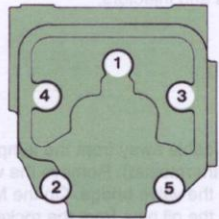

MD7

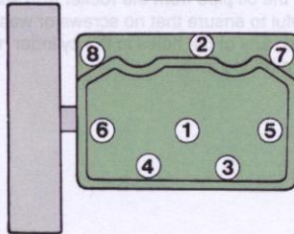

Torque wrench, socket size 15 mm:

MD5, MD7

First stage	10 Nm
Second stage	40 Nm
Third stage	70 Nm

MD11
MD17

← SVÄNGHJUL
FLYWHEEL

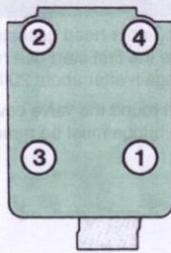

Torque wrench, socket size 19 mm:

MD11, MD17	
First stage	30 Nm
Second stage	80 Nm
Third stage	110 Nm

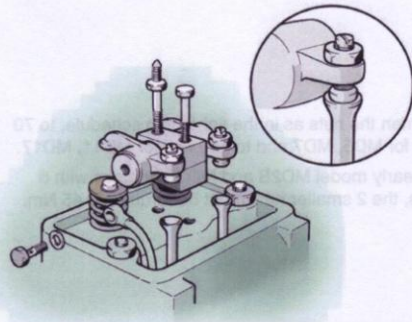

MD5, MD11, MD17

Install the push rods. Install the valve bridge. When tightening, check that the ball on the rocker arm adjustment screws is correctly located in the push rod ball sockets.

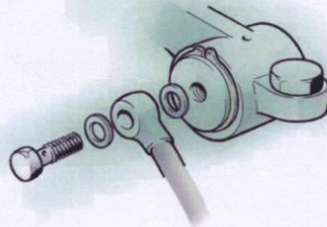

MD11, MD17

Connect the oil pipe with the hollow screw and a gasket on each side of the pipe union.

Tighten the exhaust pipe together with a new seal. Connect the fuel supply pipe to the injector, and tighten any clamps. Install the exhaust pipe elbow with a new gasket, the induction air silencer and connect the cable to the temperature sensor. Re-install the coolant pipes and tighten the hose clamps.

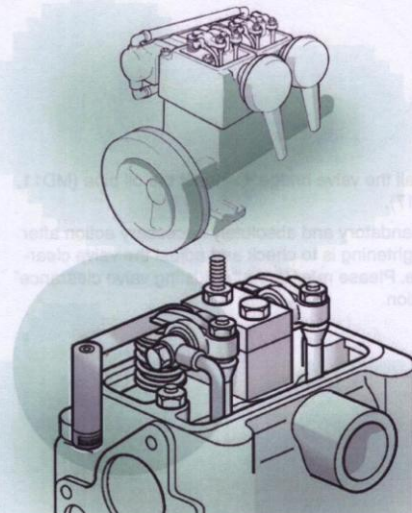

Adjust valves as follows:

Turn the flywheel in the direction of rotation until both valves on one cylinder "rock". Turn the flywheel a further complete rotation and then adjust the valves for this cylinder.

Please refer to the more detailed description under "Adjusting valve clearance". Install the valve cover temporarily, with the old gasket. Open the sea cock (if the boat is in the water), start the engine and warm it up. Check the sealing. Stop the engine, remove the valve cover and re-adjust the valve clearance if necessary, when the engine is hot. Install the valve cover with a new gasket.

Test tightening, cylinder head

The cylinder head gaskets should be re-tightened before the first start of a new or reconditioned engine, and again after about 20 hours of operation.

Clean round the valve cover and then remove it. The valve bridge must be removed for access to all nuts.

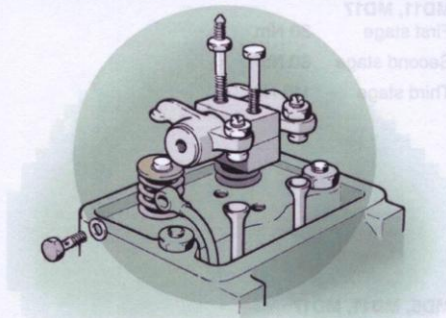

MD5

← SVÄNGHJUL
FLYWHEEL

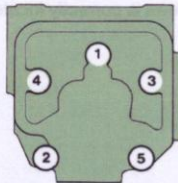

MD7

MD11
MD17

← SVÄNGHJUL
FLYWHEEL

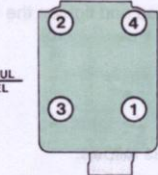
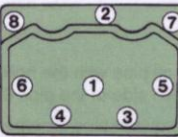

Tighten the nuts as in the tightening schedule, to 70 Nm for MD5, MD7 and to 110 Nm for MD11, MD17.

On early model MD2B and MD3B engines with 6 nuts, the 2 smaller nuts must be torqued to 45 Nm.

Install the valve bridge. Connect the oil pipe (MD11, MD17).

A mandatory and absolutely necessary action after re-tightening is to check and adjust the valve clearance. Please refer to the "Adjusting valve clearance" section.

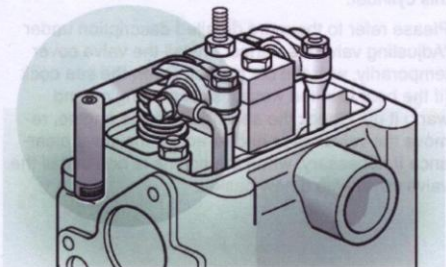

Adjusting the valve clearance

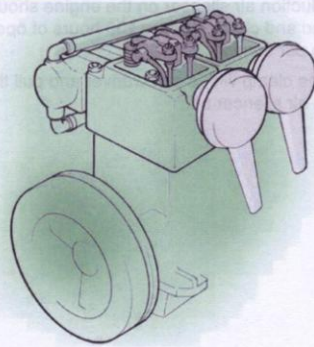

The valve clearance must always be checked and adjusted, if necessary, after the cylinder head gasket is changed, after the cylinder head nuts are re-tightened, and after every 50 hours of operation.

It is very important that the valve clearance is correctly adjusted, or unwanted noise and, in the worst case, valve failure can occur.

Run the engine until hot, if possible. Remove the valve housing. Turn the engine's flywheel in the direction of rotation (clockwise) until both valves on one cylinder "rock". Then turn the flywheel a further complete rotation and then adjust the valves for this cylinder. The procedure is the same for the other cylinders.

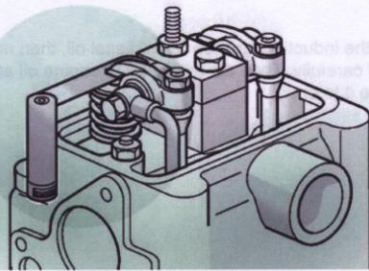

The actual adjustment is done as follows:

Slide in a feeler gauge, as in figure

The thickness of the feeler gauge should be 0.30 mm for inlet and 0.35 mm for exhaust on the MD5, MD11 and MD17. For the MD7, the thickness should be 0.30 mm for both inlet and exhaust:

When the valve clearance is correct, it should be possible to slide the feeler gauge in without any great resistance, and only slight resistance should be felt when the feeler gauge is pulled back and forwards.

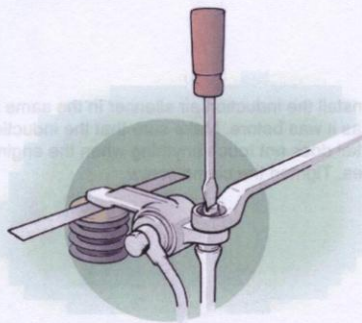

If the clearance needs to be adjusted, loosen the locknut on the adjustment screw, and then turn the adjustment screw so as to obtain correct clearance. Tighten the locknut and check that the clearance has not changed.

Repeat the procedure for the other valves.

Check the gasket for the valve cover. Change damaged gaskets. Install the valve cover.

Cleaning the induction air silencer

The induction air silencer on the engine should be removed and cleaned every 100 hours of operation, or once per season.

Undo the clamp with a screwdriver and pull the induction air silencer off.

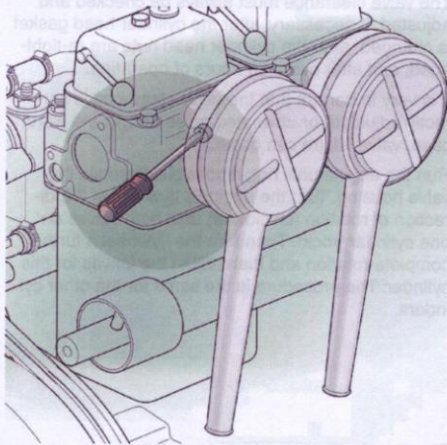

Dip the induction air silencer in diesel oil, then rinse it off carefully. Then dip the insert in engine oil and leave it to drain.



Re-install the induction air silencer in the same position as it was before. Make sure that the induction snorkel does not touch anything when the engine moves. Tighten the clamp screw.

Lubrication system

The engines have a pressure lubrication system with full flow oil filter. The oil pump is located at the front of the oil pan, and is driven from the crankshaft via an idler gear. The oil pump sucks up oil from the oil pan, through a lube oil strainer. From the delivery side of the oil pump, the oil passes through the oil filter and then out into the oil gallery.

All bearings and gudgeon pins, together with the valve mechanism and timing gear wheels, are lubricated by pressure lubrication. The engines have closed crankcase ventilation.

The following is needed to change the oil (including the oil filter):

	MD5	MD7	MD11	MD17
Oil filter	834337	834337	834337	834337
Oil volume, l	2.1	2.8	2.9	4.7
Engine with RB reversing gear, l			3.3	5.0

Oil changes in the 110S, 120S sailboat drive need 2.3 l of oil, the same grade and viscosity as for the engine. During the change, the gasket for the drain plug should be replaced by a new one, part no. 804262. The plug has part no. 804262.

An oil change in the MSB reversing gear requires 0.6 l oil and the MS2 requires 0.8 l oil, the same grade and viscosity as for the engine.

Engine, oil change

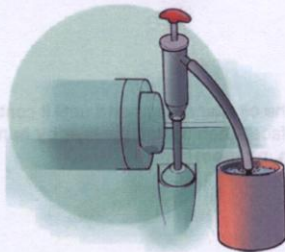

The service life of the engine mainly depends on doing oil changes and filter changes in accordance with the oil change schedule. The oil grade is very important. Choose Volvo Penta CD SAE 15W/40 or a corresponding grade from a well-known supplier. Oil and filter changes are best done at the same time as the boat is laid up for the winter.

It is easiest to drain the oil when the engine has been warmed up. This makes the oil thinner and it is also stirred round, so that any particles are dislodged from the bottom.

If the oil drain plug under the oil pan is difficult to get at, the oil can be sucked up through the dipstick hole, using an oil drain pump.

Oil drain pumps, both electric and mechanical, are available as Volvo Penta accessories.

NOTE!

Do not spill any oil. Think of the environment and hand the oil to a recycling depot.

The first oil change should be done after 20 hours of operation, if the engine is new or fully renovated. After this, oil changes should be done every 50 hours, and the oil filter must be changed every time the oil is changed.

NOTE!

The oil strainer on the MD11 (which encloses the dipstick) should not be undone. The oil can be sucked up anyway. But check that the oil strainer is securely tightened (it should be torqued to 70 Nm). If the oil strainer comes loose, it can cause engine failure.

Top up with Volvo Penta for diesel engines through the oil filler hole. Oil should be added slowly to the MD11 since the passage through the hand start mechanism is narrow.

Oil filter, change

The oil filter must be changed at the same time as the oil is changed.

The oil filter is unscrewed using a filter extractor. Be careful not to spill oil. Put a plastic bag over the oil filter before it is undone. This can prevent oil from running out into the boat.

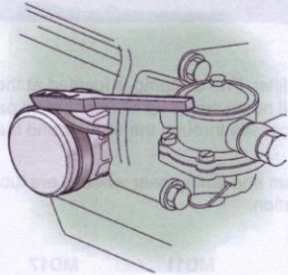

NOTE!

Also hand the oil filter to a recycling depot, since it contains some oil that must not end up with ordinary household trash.



Wipe a few drops of oil on the rubber gasket of the new filter. Clean the contact surfaces on the engine.

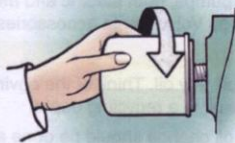

Screw the oil filter on **by hand** until it contacts the mating face. Then tighten the filter **by hand** another **1/2 turn, no more!**

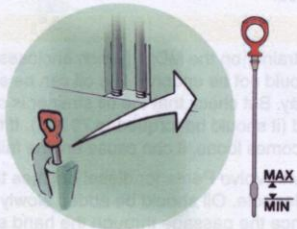

Fill up with oil to the level on the dipstick. Start the engine and check that the warning lamp for low oil pressure goes out. Stop the engine. Check that no oil leakage occurs around the oil filter.

Check the oil level and top up if necessary.

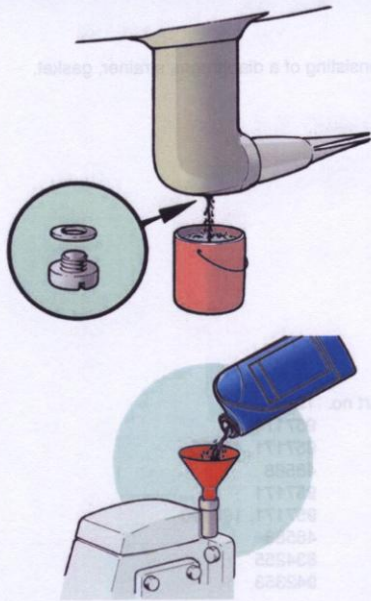
Sailboat drive, oil change

The oil in the sailboat drive should be changed at the same time as the winter lay-up.

Remove the dipstick, put a can under the drive, unscrew the oil drain plug in the base of the drive, and let all the oil run out. Check that the oil is not discolored, e.g. gray, which would indicate water in the oil. In this case, contact an authorized Volvo Penta workshop and ask them to rectify the fault. Hand the oil to a recycling depot.

Check that the drain plug seal ring is in position, and is undamaged. Screw the plug back when the oil has run out. Tighten the plug. Fill up with Volvo Penta oil for diesel engines to the correct level, through the dipstick tube.

NOTE!

On the 120 S drive, the big plug on top of the drive must be removed to make filling easier, but do not fill up this way.

The same oil grade as for the engine, CD 15W/40, should be used. This oil can also be used for the winter lay-up. No further oil change needs to be done on launching again.

Please refer to "Volvo Penta Accessories" for Volvo Penta engine oil.

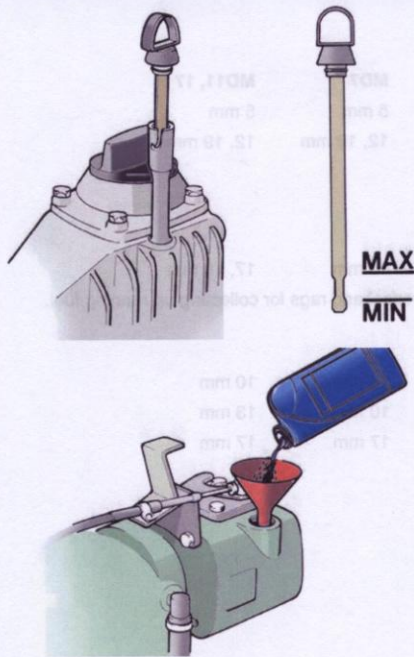
Reversing gear, oil change

The oil in the reversing gear should be changed at the same time as the winter lay-up. If the engine is used a lot during the season, the oil should be changed every 100 hours. Run the engine until hot, to make the oil flow out easier. The oil can be drained out through the bottom plug in the reversing gear, if this is easily accessible. In other cases, it must be sucked out with an oil drain pump, through the hole for the dipstick. Hand the oil to a recycling depot. Fill up with Volvo Penta oil to the correct level through the oil filler hole on the MSB and through the dipstick hole on the MS2.

NOTE!

ON the MS2 reversing gear, the big plug on top of the reversing gear must be removed to make filling easier, but do not fill up this way.

The same oil grade as for the engine, CD 15W/40, should be used. Volvo Penta engine oil can also be used for the winter lay-up. No further oil changes then need to be made on launching. In other cases, conservation oil should be used when the boat is pulled up on the shore.

Please refer to "Volvo Penta Accessories" for Volvo Penta engine oil.

Fuel system

Feed pump, MD5, MD7, MD11 and MD17

There is a complete renovation kit for renovating the feed pump, consisting of a diaphragm, strainer, gasket, center screw and gasket. Part no. 834255.

Fuel filter (primary filter).

MD5A, MD5B	Part no. 876554
MD5C	829913
MD7A	3840335
MD7B	3825133
MD11C engine no. up to 50883	870065
MD11C as from engine no. 50884	829913
MD 11 D	829913
MD17C engine no. up to 16371	870065
MD17C as from engine no. 16372	829913
MD17D	829913

Gasket for oil leakage pipe MD5, MD7	Part no. 190990
Gasket for oil leakage pipe MD11C up to engine no. 50988	957171
Gasket for oil leakage pipe MD11C as from engine no. 50989	957171, 48588
Gasket for oil leakage pipe MD11D	48588
Gasket for oil leakage pipe MD17C up to engine no. 16621	957171
Gasket for oil leakage pipe MD17C as from engine no. 16622	957171, 190990
Gasket for oil leakage pipe MD17D	48588
Feed pump, repair kit	834255
O-ring for feed pump	942353

Tools needed for the work below:

Disassembly of the feed pump

	MD5	MD7	MD11, 17
Allen key	5 mm	5 mm	5 mm
Ring wrench	12, 19 mm	12, 19 mm	12, 19 mm

Venting the fuel system

Ring wrench	10 mm		
Open end, fixed wrench	17, 18 mm	17 mm	17, 18 mm

In addition to the above tools, you need screwdrivers, a small vessel and rags for collecting up running fuel.

Changing the injectors

Ring wrench	10 mm	10 mm	10 mm
Socket	10 mm	10 mm	13 mm
Open end, fixed wrench	17 mm	17 mm	17 mm

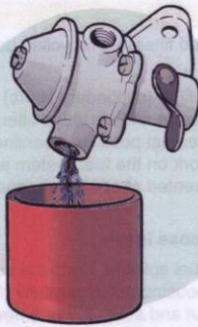
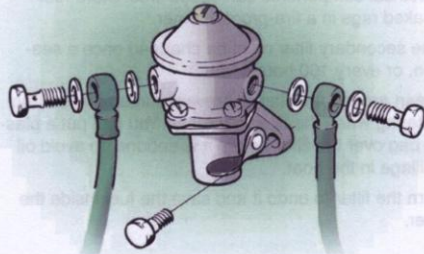

WARNING!

Remember that all fuel, incorrectly handled, is a safety risk.

Feed pump

The feed pump consists of the housing, diaphragm and lever system. The diaphragm and strainer are changed.

Cleanliness is very important whenever any work is done on the feed pump. For this reason, wipe the feed pump, pipe unions and everything close to the engine clean to prevent any dirt from getting into the fuel system.

If pump action has ceased, this is probably due to a broken diaphragm. The pump will then either have to be changed as a complete unit, or the diaphragm changed separately. In both cases, the pump has to be removed from the engine.

Start by undoing the fuel pipes from the pump, but be prepared to have small quantities of fuel run out. Undo the two socket cap screws that hold the pump. The pump will normally spring out from the block when the screws are undone.

Pour the fuel out of the pump. If the pump is to be changed as a unit, install it then with a new O-ring and tighten the screws. Connect the fuel pipes with new sealing washers.

If only the diaphragm is to be changed, undo the 6 slotted head screws. Then lift off the top of the pump. Unscrew the screw for the lever pivot and shake or poke the shaft out once the diaphragm has been pressed down to relieve the pressure on the lever. Pull the diaphragm out complete with rod and spring. Install a new diaphragm, press the diaphragm down

and insert the lever. Align the lever so that its hole lines up with the hole in the housing, then press the shaft in. Install the screw and washer, plus the spring for the lever. The pump is now ready for installation in the engine. Use a new O-ring.

After this work, the fuel system must be vented. Please refer to the "Venting the fuel system" section.

Fuel filter, change

WARNING!

Fire hazard. Work on the fuel system must be done with the engine cold. Fuel spills on hot surfaces or electrical components can cause fires. Store fuel-soaked rags in a fire-proof manner.

The secondary filter must be changed once a season, or every 100 hours.

Clean around the filter to prevent contamination from entering when the filter is undone. You can put a plastic bag over the filter before it is undone, to avoid oil spillage in the boat.

Turn the filter to undo it and save the fuel inside the filter.

NOTE!

Hand the scrapped filter to a recycling depot.

Two types of fuel filter (secondary filters) occur. Filters with loose inserts and cartridge filters (spin-on). In general, the greatest possible cleanliness must be observed in all work on the fuel system and the fuel system must be vented after filter changes.

Fuel filter with loose insert

Be prepared for fuel spillage. Undo the center screw and lift the filter housing down carefully (full of fuel). Take the insert out and scrap it. Put a new filter insert in. Check that the sealing surfaces are clean, install a new gasket and assemble the filter. Vent the system.

Fuel filter with replaceable cartridge (spin-on)

Be prepared for fuel spillage. Turn the filter with a filter wrench to remove it. Some filters have a hexagon on the base, so a crescent wrench can be used to undo them. Empty the filter and scrap it. Check that the mating surface for the filter is absolutely clean. Wipe a drop of oil on the rubber gasket for the filter. Install the filter. Tighten it by hand until the gasket just touches the filter, then turn it a further 1/2 turn. Vent the system.

Checking and replacing secondary fuel filters

The secondary fuel filter is often a combination of fuel filter and water trap. If the water trap is transparent, it is easy to see if there is water in the fuel. Water will collect in the base of the filter in this case, and can easily be removed through the drain in the base.

When the filter is changed, undo the center screw that holds the filter and the bowl together. Scrap the filter, empty and clean the bowl. Install new gaskets and a new filter, then pull the package together with the center screw. Vent the fuel system.

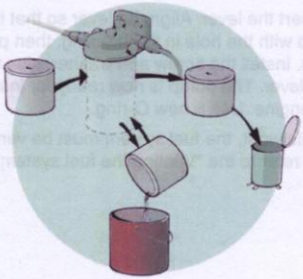
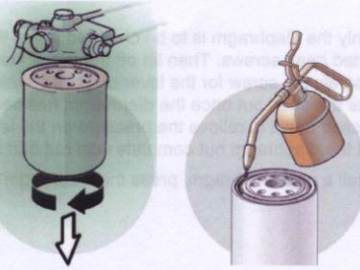
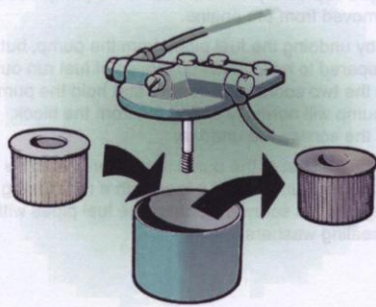

Venting the fuel system

NOTE!
 Be prepared for fuel spillage.
 Various versions of the MD5 have had either Bosch or CAV injection pumps.
 The Bosch pump is vented by turning with the hand pump for about 1/2 min. No other action is needed with the injection pump.
 The CAV pump has 2 vent screws which are vented as follows:

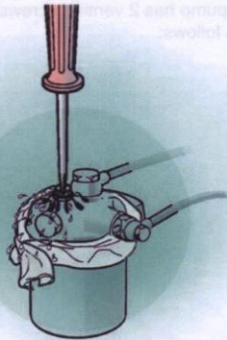

Undo screw no. 1 and pump the fuel with the hand pump until fuel flows out without any air bubbles. Tighten the venting screw. Undo screw no. 2, set the engine speed control to full speed and crank the engine with the starter motor until fuel flows out without any air bubbles. Tighten the venting screw.

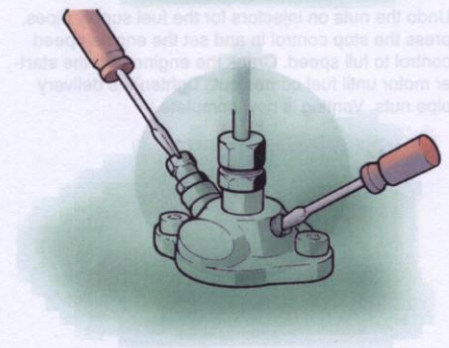

The fuel system must be vented as follows:

- During all work on the system where something has been undone so that fuel leaks out, such as filter changes.
- Running the fuel tank dry.
- After a long stoppage or first time the engine is started.

The venting procedure differs slightly between each engine type.

Venting the fuel filter (secondary filter)

NOTE!

Be prepared for fuel spillage.

Open the vent screw on the fuel filter about 4 turns. Pump the fuel out with the hand pump until fuel flows out without any air bubbles. Close the venting screw. If pump action is poor, turn the engine round slightly, to make the pump drive cam change position.

Venting the injection pump and injectors, MD5

NOTE!

Be prepared for fuel spillage.

Venting the injector pump on engines with engine numbers below 3809 is done as follows:

Open the venting screw on the injection pump. Operate the hand pump until fuel without air bubbles comes out. Close the venting screw. Then loosen the pressure valve union on the pump and the injector fuel supply pipe nut. Pump with the hand pump or crank the engine with the starter motor until pure fuel without air bubbles flows out. Tighten the injector fuel supply (35 - 40 Nm) and the injector fuel supply pipe nut.

Engines with engine number above 3809:

Open the vent screw on the injection pump and the tiny countersunk screw on the cover. Operate the hand pump until fuel without air bubbles comes out. Close the vent screws. Loosen the injector fuel supply pipe nut, pump with the hand pump or crank the engine with the starter motor until pure fuel without air bubbles flows out, then tighten the nut again. Venting is now complete.

Venting the Injection pump and injectors, MD7

NOTE!

Be prepared for fuel spillage.

Various versions of the MD7 have had either Bosch or CAV injection pumps.

The Bosch pump is vented by pumping with the hand pump for about 1/2 min. No other action is needed with the injection pump.

The CAV pump has 2 venting screws which are vented as follows:

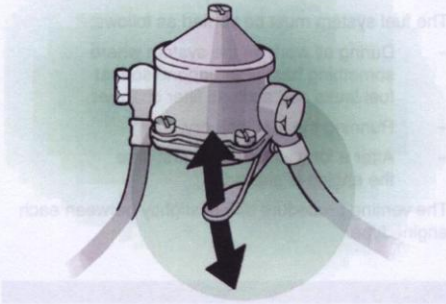

NOTE!
Be prepared for fuel spillage.
Open the vent screw on the fuel filter about 4 turns.
Pump the fuel out with the hand pump until fuel flows
out without any air bubbles. Close the venting screw.
If pump action is poor, turn the engine round slightly
to make the pump draw fuel in the correct position.

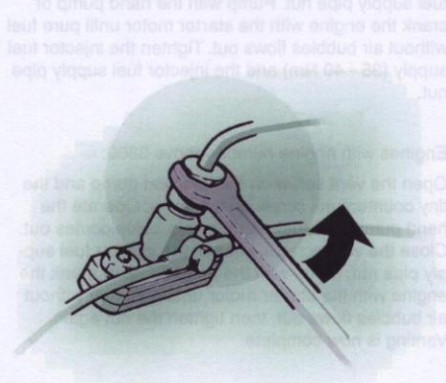
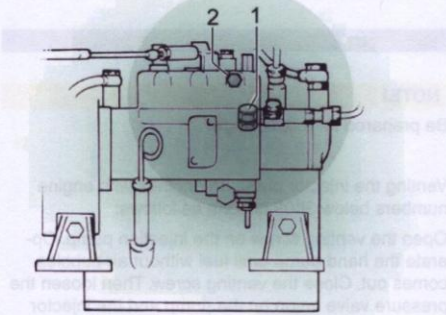

Undo screw no. 1 and pump the fuel with the hand pump until fuel flows out without any air bubbles. Tighten the venting screw. Undo screw no. 2, set the engine speed control to full speed and crank the engine with the starter motor until fuel flows out without any air bubbles.

Tighten the venting screw.

Undo the nuts on injectors for the fuel supply pipes, press the stop control in and set the engine speed control to full speed. Crank the engine with the starter motor until fuel comes out. Tighten the delivery pipe nuts. Venting is now complete.

Venting the pump and injectors, MD11, MD17

NOTE!

Be prepared for fuel spillage.

Open the vent screw on the injection pump about 2 turns. Press the hand pump until air-free fuel flows out. Tighten the venting screw.

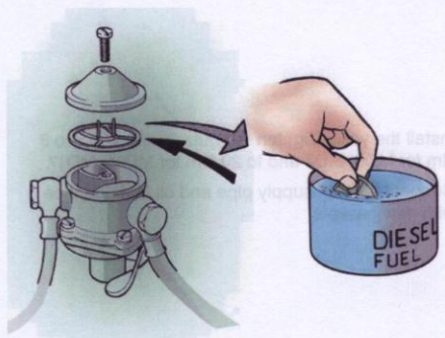
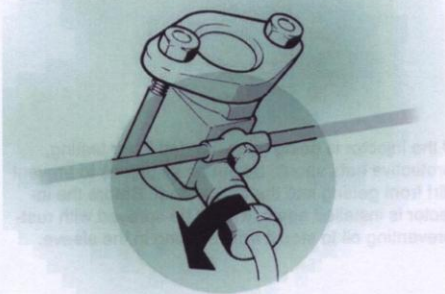
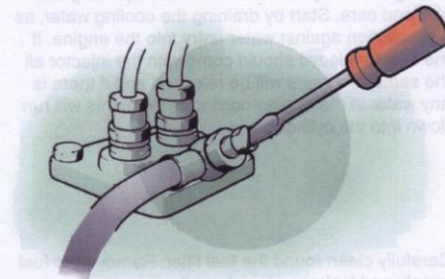

Undo the nuts on injectors for the fuel supply pipes, press the stop control in and set the engine speed control to full speed. The MD11C has a cold start button which should be depressed. Crank the engine with the starter motor until fuel comes out. Tighten the delivery pipe nuts.

Cleaning the fuel strainer

The feed pump on the engine is provided with a strainer located under the cover. The strainer must be cleaned at least once per season. Be prepared for fuel spillage when the cover is removed. Note the position of the strainer when it is removed. Rinse the strainer and shake it dry. Wipe any dirt out of the housing and the cover before the fuel strainer is re-installed.

The fuel system must be vented before this work is done. Coordinate work on the fuel system, e.g. change the fuel filter at the same time.

Check immediately after starting that no fuel leakage occurs. If fuel leaks out, air will leak in, which will lead to malfunctions.

Changing the Injectors

⚠ IMPORTANT!

Taking out an injector is a task that requires great skill and care. Start by draining the cooling water, as a precaution against water entry into the engine. If the injector sleeve should come with the injector all the same, the seals will be released and if there is any water in the engine cooling system, this will run down into the cylinder.

Carefully clean round the fuel filter. Remove the fuel supply and leakage pipes from the injector. Be prepared for fuel spillage. Bend the pipes back slightly. Remove the yoke holding the injector. Turn the injector back and forwards a few times to loosen it from the sleeve. Then carefully pull the injector up at the same time as it is turned back and forwards.

If the injector is going to be handed in for testing, protective hats should be put on all unions to prevent dirt from getting into the fuel system. Before the injector is installed again, it must be sprayed with rust-preventing oil to stop it from sticking in the sleeve.

Install the yoke. Tighten the nuts for the yoke, to 8 Nm for MD5, MD7 and to 20 Nm for MD11, MD17. Connect the fuel supply pipe and oil leakage pipe with new gaskets.

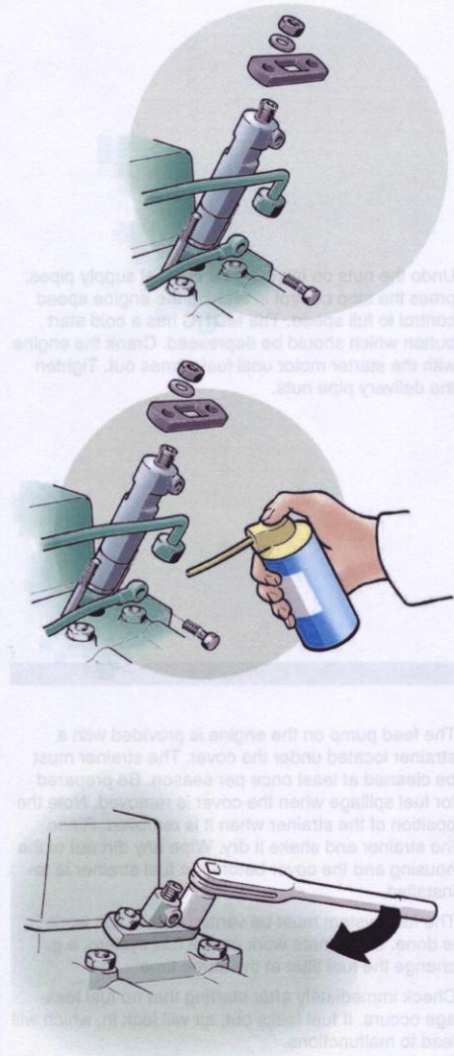

Cooling system

NOTE!

The descriptions in this chapter refer to standard versions, i.e. engines with sea water cooling. If the engine is equipped with fresh water cooling (optional), it may differ from the descriptions and illustrations.

Sea water pump

When just the impeller is changed, the following components are used:
Impeller kit, including cover gasket.

	Part no.
MD5, MD7, MD11	3586496
MD17	3586497
Repair kit containing seal rings, shaft, cam, gasket etc. :	

	Part no.
MD5, MD7, MD11	875584
MD17	875698
Individual seal rings (2 pcs).	833996

Thermostat and seal ring

MD5	875783 and 838013.
The MD5A and B also need 2 seal rings part no. 829714 and the MD5C needs 3 pcs part no. 829714.	
MD7, MD11, MD17	875796 and 416033.
MD11 with fresh water cooling	877349
MD17 with fresh water cooling	416033

The following tools are needed for the work below.

Disassembly of the seawater pump	MD5	MD7	MD11, MD17
Allen key	6 mm		
Ring wrench		13 mm	13 mm

In addition to the tools above, you need 2 screwdrivers of about 7 mm blade width.

Changing the thermostat	MD5	MD7	MD11, MD17
Allen key	6 mm		
Ring wrench	10 mm	13 mm	13 mm

In addition to the tools above, you need a screwdriver.

Coolant hoses

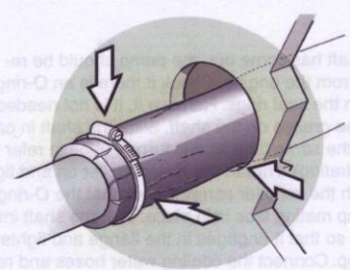

The cooling water hoses are made of rubber. Rubber ages and can be exposed to chafing. For this reason, check regularly that the rubber does not feel hard or cracked, and that the hoses do not lie and chafe against sharp edges.

Change hoses which are damaged in any way.

Also check that the hose clamps are not corroded and that they are correctly located and tightened. Install stainless hose clamps as necessary.

Impeller, change

The component in the seawater pump which is most exposed to wear is the impeller.

The wear will increase if the boat is run in very sandy water, for example or in shallow water where seaweed can get in and cause heavy loading on the vanes. If the seawater pump has been run without water, the impeller will quickly be damaged and must be repaired.

Excessive engine temperature can be caused by poor pump action due to a damaged impeller.

Before the cover on the pump is undone, the sea cock must be closed, or if an S-drive is installed, the tap on the drive must be closed. Do not forget to open the tap again when the work is finished. Change the impeller as follows:

Undo the cover. Some water will run out.

⚠ WARNING!

Be careful not to let water get in! Never leave the boat until you have ensured that water can not find its way in under any circumstances and sink the boat.

Two different designs of impeller installation occur. In the early model, the impeller and shaft are pulled out 10-15 mm. After this, the flange screw that is inserted transversely through the impeller and shaft is undone. It is important that the shaft should not come out further, so hold the shaft in place and pull the impeller off.

Late model impellers can be pulled out without undoing the flange screw. In addition, the shaft is locked axially so it can not come out with the impeller. The shaft has a groove that is visible when the cover is removed.

Clean the inside of the pump housing and scrape off any gasket remains. Tighten the flange screw in the impeller a few turns on early models and tighten it completely on later models. Press the impeller in so far that the screw can be tightened on the shaft in early models. On late models, the impeller is pressed in so that the screw engages in the groove in the shaft. Install the lid with a new seal.

If the shaft has come out, the pump should be removed from the engine. Check if there is an O-ring between the seal rings. Remove it, it is not needed. Put some grease on the shaft. Slide the shaft in carefully, at the same time as it is turned (please refer to the illustration). Thread the new impeller on and tighten it with the impeller screw. Check that the O-ring on the pump mating face is in place. Turn the shaft into position so that it engages in the flange and tighten the pump. Connect the cooling water hoses and reopen the shut-off tap for the cooling water.

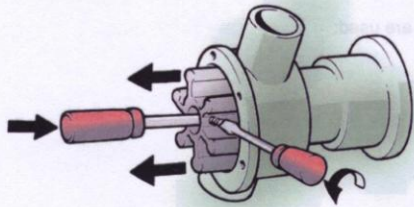

Renovating the seawater pump

The seal rings in the sea water pump can be damaged by sandy water etc. The seal ring closest to the impeller is the one that is damaged first. One sign of this is that water leaks out of the pump housing drain hole. If this happens, the seal rings should be changed as quickly as possible. Close the sea cock or the tap on the S-drive.

⚠ WARNING!

Be careful not to let water get in! Never leave the boat until you have ensured that water can not find its way in under any circumstances and sink the boat.

Undo the cooling water unions from the pump. Remove the pump from the engine. Disassemble the pump, check the impeller and change if necessary, and press the seal rings out. Clean the housing carefully. Check that there are no burrs on the shaft. If the bushing is worn, it must be changed. If there was a small O-ring on the shaft between the seal rings, it should not be re-installed.

Install new seal rings. The seal closest to the impeller should seal against water, and should thus have its open side with the sealing lip and spring ring facing the impeller. The other seal ring should seal against oil, and should therefore face the other way, with the sealing lip facing the engine. Position the seal rings so that they do not block the water leakage hole in the pump housing.

Put grease on the shaft and press it in through the seal rings while turning it, from the pump impeller side. Press the impeller in, and on early models fix the impeller with the flange screw. Install the lid with a new seal. Re-install the pump on the engine together with a new O-ring and connect the cooling water pipes. Open the sea cock or tap on the S-drive.

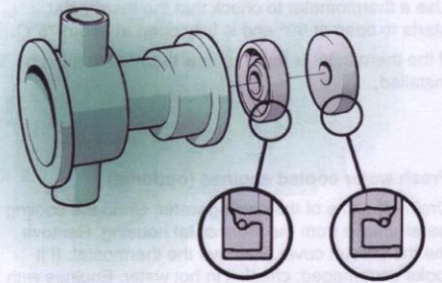
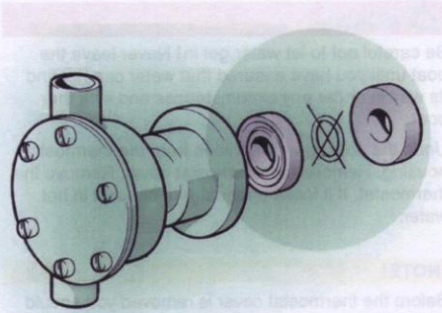

Thermostat

Checking and changing the thermostat.

If the engine runs hot or is too cold, the reason could be that the thermostat opens at the wrong temperature, or does not open at all. Another possible reason could be a fault in the temperature sensor, which makes the coolant alarm trip, or there could be a fault in the temperature gauge (optional).

Sea water cooled engines (standard)

Drain off some of the cooling water.

WARNING!

Be careful not to let water get in! Never leave the boat until you have ensured that water can not find its way in under any circumstances and sink the boat.

Undo the cooling water unions from the thermostat housing. Remove the thermostat cover. Remove the thermostat. If it looks undamaged, check it in hot water.

NOTE!

Before the thermostat cover is removed you should drain off some of the cooling water.

Use a thermometer to check that the thermostat starts to open at 60° and is fully open at about 75°C.

If the thermostat is faulty, a new thermostat must be installed.

Fresh water cooled engines (optional)

Drain off some of the cooling water. Undo the cooling water unions from the thermostat housing. Remove the thermostat cover. Remove the thermostat. If it looks undamaged, check it in hot water. Engines with fresh water cooling have a thermostat with a different opening temperature. Please refer to the instruction for the engine/accessory kit.

NOTE!

Coolant is hazardous for the environment. Process it in a responsible manner. If the coolant does not need to be changed for age reasons, it can be put back again.

All engines.

Install the thermostat with a new gasket and tighten the thermostat cover again. Connect the coolant pipes again. Always carry a new thermostat aboard.

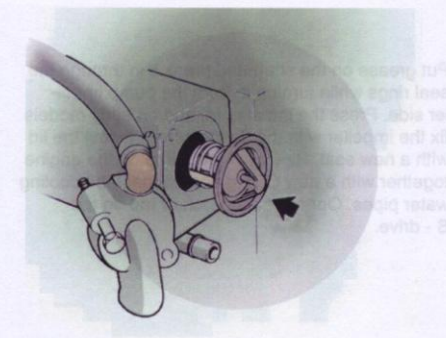
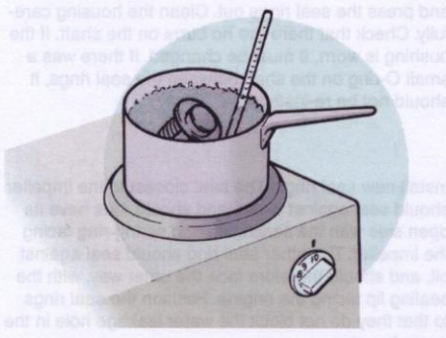
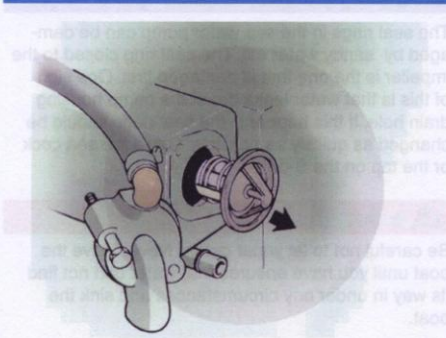

Vacuum valve

If a vacuum valve is installed in the cooling system, it must be taken apart for cleaning after every season, or if leakage should occur.

Undo the hoses from the valve. Remove the valve from the bulkhead. Hold the valve upside down and unscrew the nut. Be careful to ensure that the small diaphragm (1) and gasket (2) do not fall off.

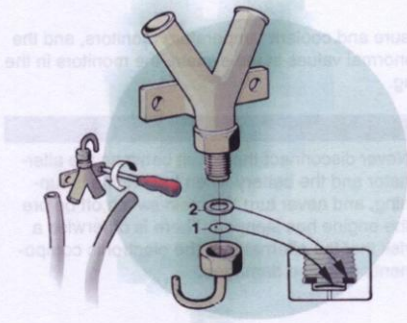

Clean the components in fresh water, make sure that any salt deposits are removed.

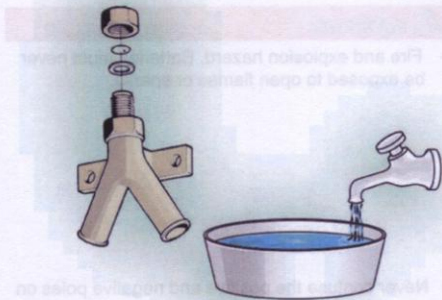

Hold the valve nut upside down, put the diaphragm in and then the gasket. Hold the valve upside down as well and screw the nut on.

NOTE!

Tighten carefully, only 2 Nm. If the nut is tightened harder, there is a risk that the valve might not work. Test the valve by sucking air through the hole in the nut (or pipe on later models). Re-install the vacuum valve on the bulkhead and connect the hoses. Tighten the hose clamps.

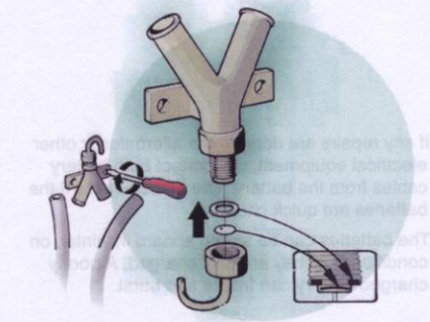

Electrical system

As standard, the engines have a 1-pole electrical system. System voltage is 12 Volt. The energy source for the electrical system is an alternator. The electrical system is protected by fuses.

The main components in the electrical system are as follows:

Battery, main switch, starter motor, alternator, fuse box, oil pressure and coolant temperature monitors, and the MD17 also has an engine speed sensor. Whenever there are abnormal values in the system, the monitors in the system send an impulse to the alarm, which then gives a warning.

General advice

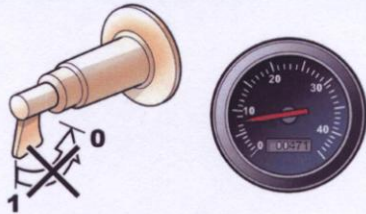

- Never disconnect the circuit between the alternator and the battery when the engine is running, and never turn the main switch off before the engine has stopped. There is otherwise a risk that the alternator or the electronic components could be damaged.

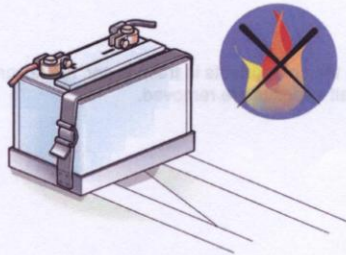

⚠ WARNING!

- Fire and explosion hazard. Batteries must never be exposed to open flames or sparks.

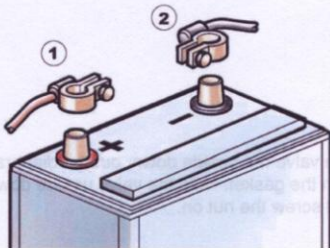

- Never confuse the positive and negative poles on the batteries. When you connect batteries, first connect the + cable (red) to the + pole on the battery. Then connect the - cable (black) to the - pole on the battery.

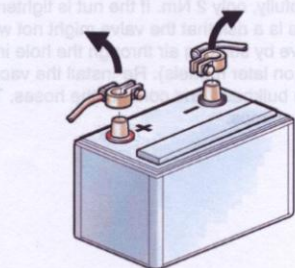

- If any repairs are done to the alternator or other electrical equipment, disconnect both battery cables from the battery. The same applies if the batteries are quick charged.
- The batteries can be stored aboard in winter, on condition that they are fully charged. A poorly charged battery can freeze and burst.



- Regularly check the cables, tightening of terminals and clamping of cables. Cables which are not used should be isolated.



- Extra equipment should not be connected to the ordinary engine cables, unless Volvo Penta's installation instruction permits it. The cable harness is dimensioned for the load on each circuit.

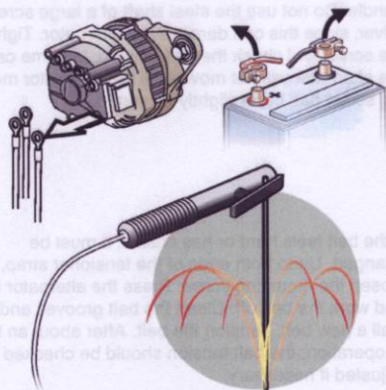

- If any electric welding is done on board, the battery cables and all cables leading to the alternator must be lifted off and isolated. The earth clamp on the welder must be connected in such a way that the current does not pass through any bearings.

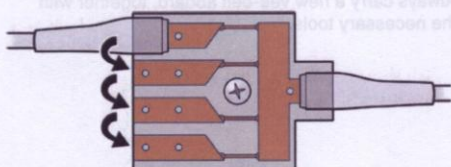

Changing the fuse

There is a fuse box in the electrical system. The fuse cuts off the electrical system if it is overloaded. Re-connect the electrical system by moving the cable terminal to the next outlet connector.

NOTE!

Always carry spare fuses on board.

Alternator belt

WARNING!

Stop the engine before doing any maintenance work.

Inspection, adjustment, change

The service life of the vee-belt mainly depends on cleanliness in the engine bay, and above all that the belt tension is correctly adjusted. A vee-belt that is allowed to run in oily water is quickly destroyed. A belt which is too loose can slip on the pulleys, which would make the friction temperature very high, mechanical wear increases rapidly and alternator charge falls.

For this reason, keep the area round the vee-belt clean and check the belt tension often. **Inspection and any adjustment should be done after operation, when the belt is hot.**

It should be possible to press a correctly tensioned belt down 5 mm between the pulleys, not more. If the vee-belt is tensioned too hard, this can damage both the belt and the bearing in the alternator.

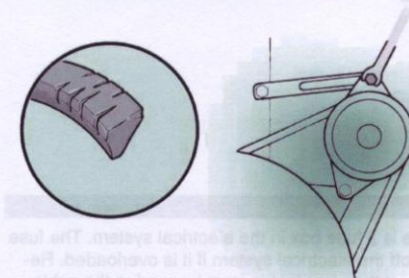
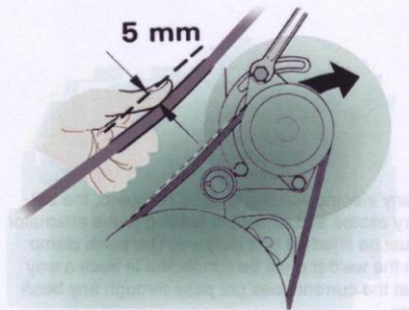
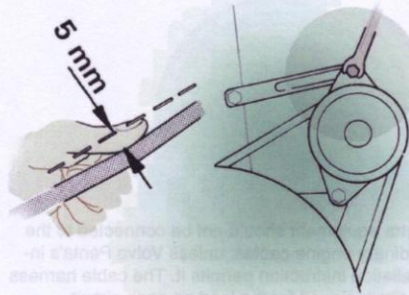

Adjust the belt tension as follows:

Undo the screw holding the tensioner strap on the alternator, and pull the alternator out using a wooden handle. Do not use the steel shaft of a large screwdriver, since this can damage the alternator. Tighten the screw and check the belt tension. In some cases, the alternator will not move until the alternator mounting screw has been slightly loosened.

If the belt feels hard or has cracks, it must be changed. Undo both ends of the tensioner strap, and loosen the mounting screw. Press the alternator in and work the belt off. Clean the belt grooves and install a new belt. Tension the belt. After about an hour of operation, the belt tension should be checked and adjusted if necessary.

NOTE!

Always carry a new vee-belt aboard, together with the necessary tools.

Wiring diagrams

MD5

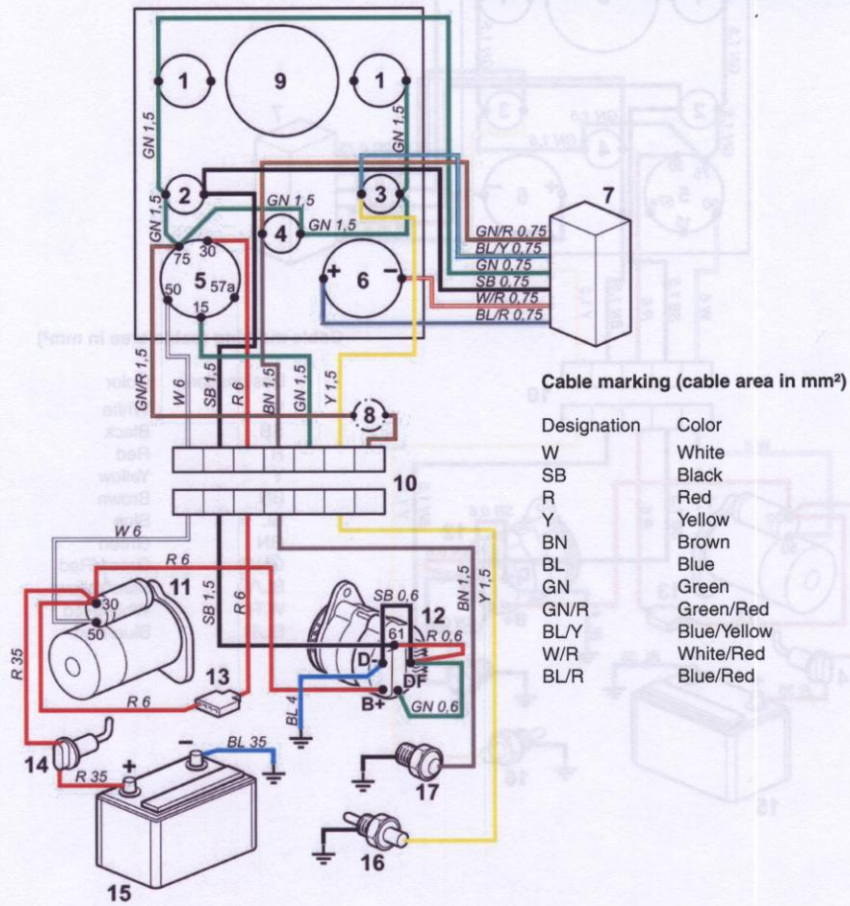

Cable marking (cable area in mm²)

Designation	Color
W	White
SB	Black
R	Red
Y	Yellow
BN	Brown
BL	Blue
GN	Green
GN/R	Green/Red
BL/Y	Blue/Yellow
W/R	White/Red
BL/R	Blue/Red

Position list

- | | |
|---|---|
| <ul style="list-style-type: none"> 1. Switch, extra 2. Charge indication lamp bulb 3. Warning lamp, for high temperature 4. Warning lamp, for low oil pressure 5. Key switch 6. Siren 7. Alarm unit 8. Charge indication lamp (for 2:nd battery circuit, optional equipment) 9. Place for instrument, optional equipment | <ul style="list-style-type: none"> 10. Quick release connector 11. Starter motor 12. Alternator 13. Fuse box 14. Main switch 15. Battery 16. Temperature sensor 17. Oil pressure sensor |
|---|---|

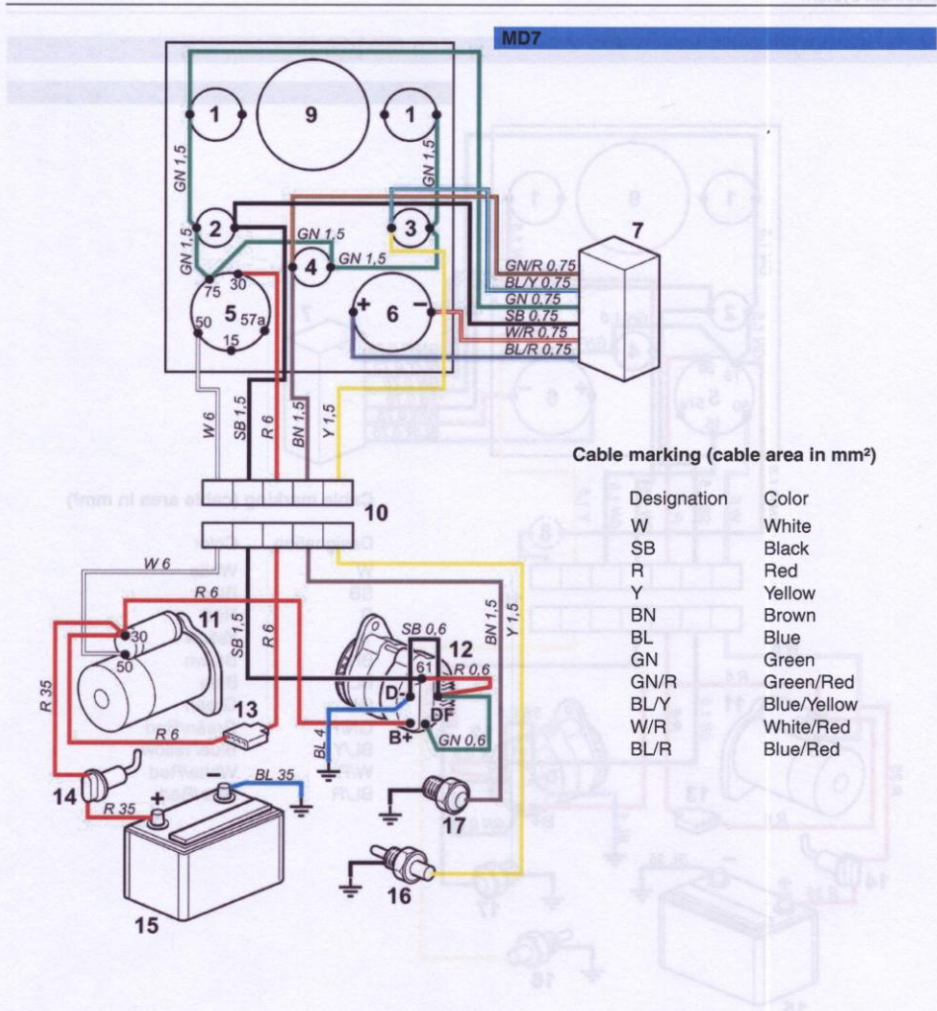

Position list

- | | |
|--|--|
| <ol style="list-style-type: none"> 1. Switch, extra 2. Charge indication lamp bulb 3. Warning lamp, for high temperature 4. Warning lamp, for low oil pressure 5. Key switch 6. Siren 7. Alarm unit 8. - | <ol style="list-style-type: none"> 9. Place for instrument, optional equipment 10. Quick release connector 11. Starter motor 12. Alternator 13. Fuse box 14. Main switch 15. Battery 16. Temperature sensor 17. Oil pressure sensor |
|--|--|

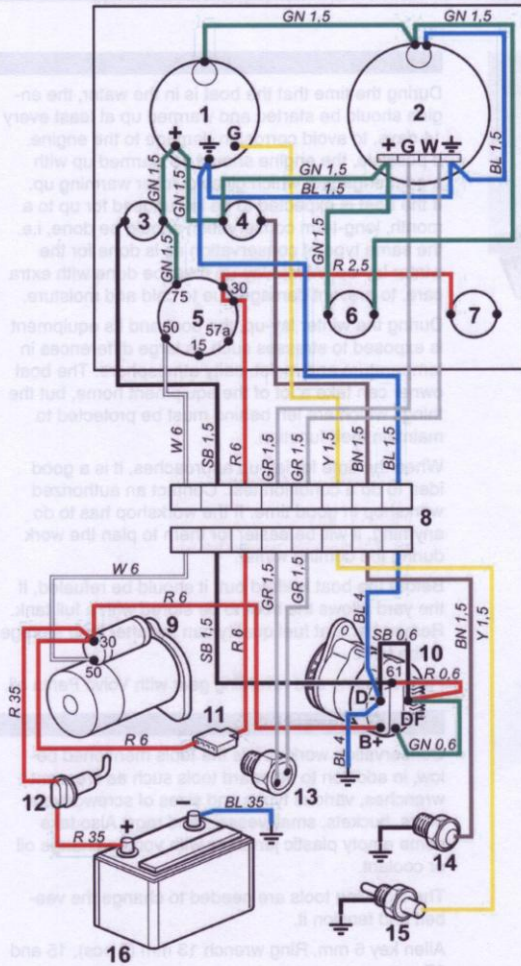

Cable marking (cable area in mm²)

Designation	Color
W	White
SB	Black
R	Red
Y	Yellow
BN	Brown
BL	Blue
GN	Green
GR	Gray

Position list

- | | |
|---------------------------------------|-------------------------|
| 1. Temperature gauge | 9. Starter motor |
| 2. Tachometer | 10. Alternator |
| 3. Charge indication lamp | 11. Fuse box |
| 4. Warning lamp, for low oil pressure | 12. Main switch |
| 5. Key switch | 13. Engine speed sensor |
| 6. Switch, instrument lighting | 14. Oil pressure sensor |
| 7. Switch, extra equipment | 15. Temperature sensor |
| 8. Connector | 16. Battery |

Conservation

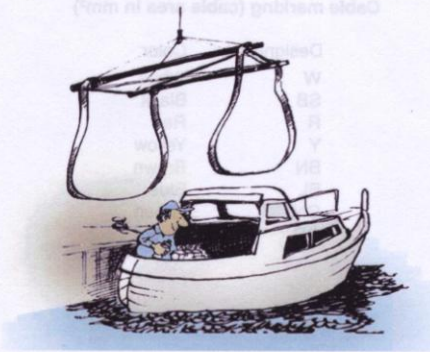
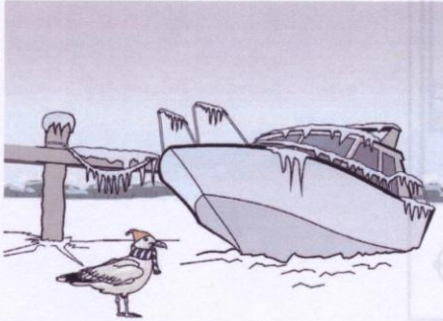

General

During the time that the boat is in the water, the engine should be started and warmed up at least every 14 days, to avoid corrosion damage to the engine. If possible, the engine should be warmed up with a gear engaged, which gives quicker warming up. If the boat is expected to be left unused for up to a month, long-term conservation should be done, i.e. the same type of conservation as is done for the winter lay-up. Winter lay-up must be done with extra care, to prevent damage due to cold and moisture.

During the winter lay-up, the boat and its equipment is exposed to stresses such as large differences in temperature and moist, salty atmosphere. The boat owner can take a lot of the equipment home, but the things which are left behind must be protected to maintain their function.

When the time for lay-up approaches, it is a good idea to do a condition test. Contact an authorized workshop in good time. If the workshop has to do anything, it will be easier for them to plan the work during the coming winter.

Before the boat is lifted out, it should be refueled, if the yard allows the boat to be stored with a full tank. Remember that fuel quality can fall after long storage in the tank.

Fill the engine and reversing gear with Volvo Penta oil.

Laying up, preparations

Conservation work needs the tools mentioned below, in addition to standard tools such as crescent wrenches, various types and sizes of screwdrivers, pliers, buckets, small vessels and rags. Also take some empty plastic jerricans with you, to change oil or coolant.

The following tools are needed to change the vee-belt and tension it.

Allen key 6 mm. Ring wrench 13 mm (2 pcs), 15 and 17 mm.

Oil change, engine and reversing gear

This task can well be done when the boat is in the water. Run the engine until warm, to make the oil flow easier. Stop the engine and pump the engine oil or transmission oil out with an oil drain pump. Hand the old oil to a recycling depot.

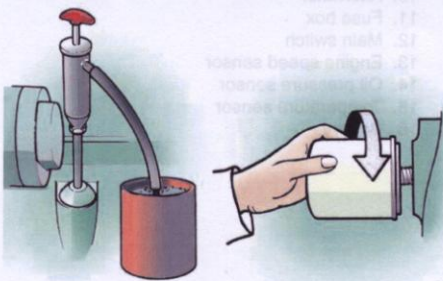

WARNING!

Hot oil and hot surfaces can cause burns.



The oil viscosity and grade is SAE 15W/40. The oil grade, CD, is used for diesel engines and also complies with the requirements for winter lay-up oil. If this oil is used, no oil change is needed before launching. Please refer to the instruction book or the "Oil change" section for the amount of oil required. If the boat is laid up for a longer period than normal, the engine and reversing gear should be filled up with special conservation oil.

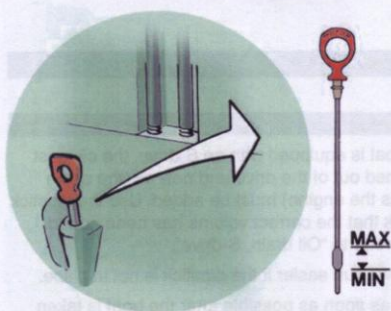

Also use the dipstick to check that the correct oil level has been reached after the oil change. Since the oil filter is also changed, the level will always fall slightly when the engine has been run and the filter has been filled with oil.

IMPORTANT!

Never fill up above the maximum oil level. If special conservation oil is used, this must be drained off before launching, and engine oil with the above quality specification must be added.

Fuel filter, change

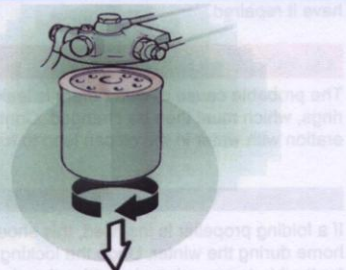

This task can well be done when the boat is in the water. Change the secondary filter in the fuel system and empty the water trap, if fitted, to ensure that no water is left behind during the winter. Be careful not to spill fuel. Please refer to the "Fuel system" chapter for further information.

NOTE!

Hand the scrapped filters to a recycling depot.

Laying up

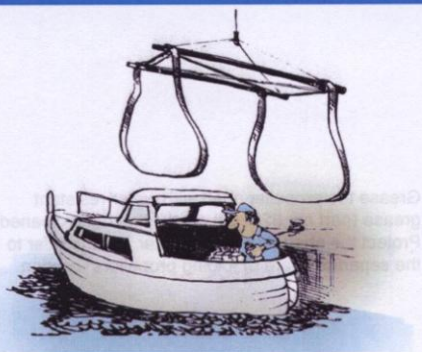

The next phase in conservation work is taking the boat out of the water. Conservation continues with the following points:

Cleaning

Clean the boat and, if installed, the S-drive, to remove fouling straight after the boat is pulled out, to stop it from drying on.

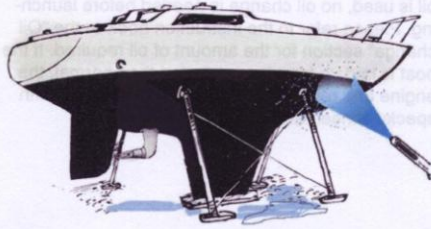

IMPORTANT!

Be very careful if using a power washer for cleaning. The water jet must never be directed against the propeller shaft seal, or the rubber seal and bellows on the S-drive.

S - drive

Oil change

If the boat is equipped with an S-drive, the oil must be drained out of the drive and new oil (the same grade as the engine) must be added. Use the dipstick to check that the correct volume has been added. Please refer to "Oil drain, S-drive".

The oil will run easier if the dipstick is not in place.

Do this as soon as possible after the boat is taken up.

If the old oil is milky or gray, water has found its way into the drive. Contact an authorized workshop to have it repaired.

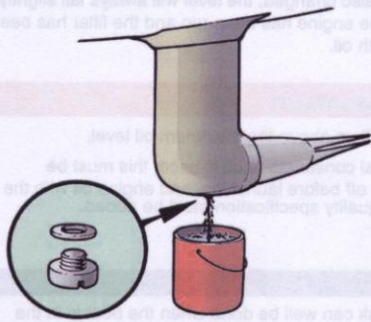

IMPORTANT!

The probable cause of water entry is leaky seal rings, which must then be changed. Continued operation with water in the oil can lead to total failure!

Propellers

If a folding propeller is installed, this should be taken home during the winter. Undo the locking screws for the blade mounting pins, drive the pins out and remove the blades. Undo the propeller shaft nut and pull the propeller hub off.

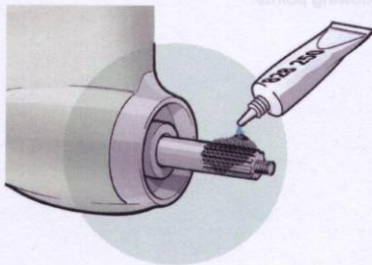
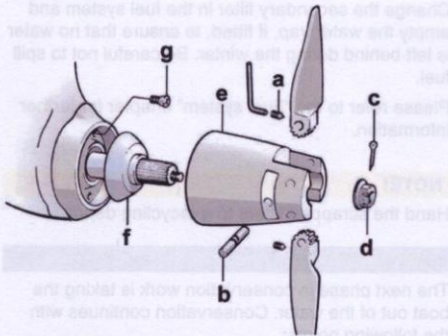

Grease the propeller shaft with water-resistant grease (part no. 828250) after it has been cleaned. Protect the shaft during the winter. Please refer to the separate "Care of folding propellers" section.

Cooling system

After the boat has been put on blocks and cleaned, it is time to start conserving the engine cooling system. The procedure differs, depending on whether the engine is seawater cooled or fresh water cooled (optional).

Seawater cooled engines

Drain the cooling water. Remove the thermostat housing cover and take the thermostat out. Re-install the cover and the thermostat gasket.

Flushing

It is necessary to run the engine at idle to do conservation of the cooling system. Conservation should be done on land.

The cooling system must first be flushed with fresh water, to prevent deposits and salt crystals from accumulating in the cooling system.

Organize a collection vessel under the exhaust outlet, to collect the cooling water.

Connect a hose to the suction side of the sea water pump. The hose should be so long that it reaches down to the collection vessel, to allow the cooling water to re-circulate.

Organize a mixture of half water and half glycol in a bucket. Undo the hose on the sea water pump suction side (engines with S-drive) and connect a longer hose that reaches down to the bottom of the bucket. On engines with a reversing gear, connect a hose to the suction side of the reversing gear.

Check that nothing can be splashed from the exhaust outlet. Put the engine control in neutral. Check that there is nothing close to the propeller.

Start the engine and let it idle until the bucket is empty, or circulate the mixture for a few minutes.

⚠ WARNING!

Working with an engine which is operating is a safety hazard. Watch out for rotating components and hot surfaces.

Stop the engine at once when the bucket is empty.

⚠ IMPORTANT!

The impeller in the sea water pump will be damaged if it runs without water.

For environmental reasons, the mixture should always be collected from the exhaust outlet, and it should be run through several times. The mixture does not need to be drained. If any other type of conservation preparation is used, which does not have frost protection, this must be drained to stop the engine being destroyed by frost.

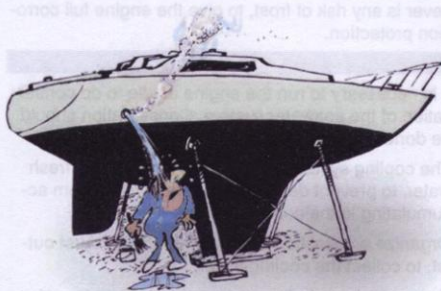
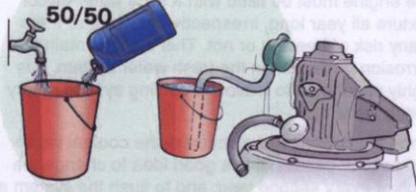
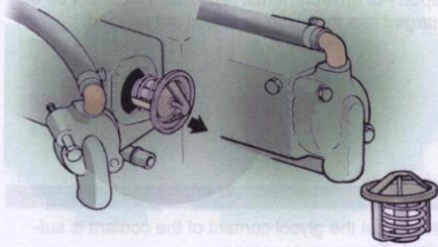

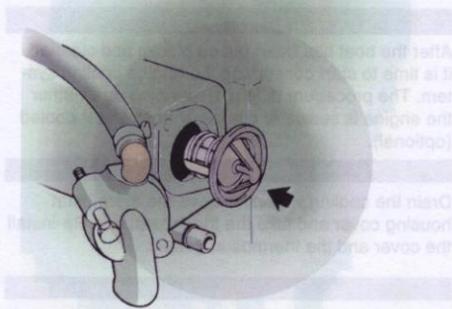

Re-install the thermostat. Use a new gasket. Connect the cooling water hose to the pump or to the reversing gear.

NOTE!

The mixture must be drained before launching. Re-use the mixture next season, or hand it to a recycling depot. For environmental reasons, it must not be discharged into the water or tipped out on land.

Fresh water cooled engines (optional)

Check that the glycol content of the coolant is sufficient. Top up as necessary.

NOTE!

The engine must be filled with a 50% water-glycol mixture all year long, irrespective of whether there is any risk of freezing or not. This is to maintain the corrosion protection in the fresh water system. It is highly unsuitable to leave the cooling system empty during the winter.

Since the corrosion protection of the coolant weakens as time passes, it is a good idea to change the coolant every second year, and to flush the system at the same time.

IMPORTANT!

Coolant of a suitable chemical formula must be used all year round. This also applies in areas where there never is any risk of frost, to give the engine full corrosion protection.

Flushing, Sea water system

It is necessary to run the engine at idle to do conservation of the seawater system. Conservation should be done on land.

The cooling system must first be flushed with fresh water, to prevent deposits and salt crystals from accumulating in the cooling system.

Organize a collection vessel under the exhaust outlet, to collect the cooling water.

Connect a hose to the suction side of the sea water pump. The hose should be so long that it reaches down to the collection vessel, to allow the cooling water to re-circulate.

Organize a mixture of half water and half glycol in a bucket. Undo the hose on the sea water pump suction side (engines with S-drive) and connect a longer hose that reaches down to the bottom of the bucket. On engines with a reversing gear, connect a hose to the suction side of the reversing gear.

After the boat is launched, it is time to check the engine. The gasket on the thermostat cover (optional). Drain the cooling water. Turn the cover at the pump. It is necessary to run the engine at idle to do conservation of the cooling system. Conservation should be done on land. The cooling system must first be flushed with fresh water, to prevent deposits and salt crystals from accumulating in the cooling system. Organize a collection vessel under the exhaust outlet, to collect the cooling water. Connect a hose to the suction side of the sea water pump. The hose should be so long that it reaches down to the collection vessel, to allow the cooling water to re-circulate. Organize a mixture of half water and half glycol in a bucket. Undo the hose on the sea water pump suction side (engines with S-drive) and connect a longer hose that reaches down to the bottom of the bucket. On engines with a reversing gear, connect a hose to the suction side of the reversing gear. Check that nothing can be spilled from the bucket. Put the engine cover back on. Check that there is nothing close to the propeller. Start the engine and let it idle until the bucket is empty or circulate the mixture for a few minutes.

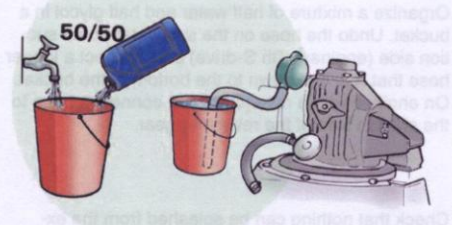

Check that nothing can be spilled from the bucket. Put the engine cover back on. Check that there is nothing close to the propeller. Start the engine and let it idle until the bucket is empty or circulate the mixture for a few minutes. Working with an engine which is operating is a safety hazard. Watch out for rotating components and hot surfaces. Stop the engine as soon as the bucket is empty.

The impeller in the sea water pump will be damaged if it runs without water. For environmental reasons, the mixture should always be collected from the exhaust outlet, and it should be run through several times. The mixture does not need to be drained. If any other type of conservation preparation is used, which does not have frost protection, this must be drained to stop the engine being destroyed by frost.

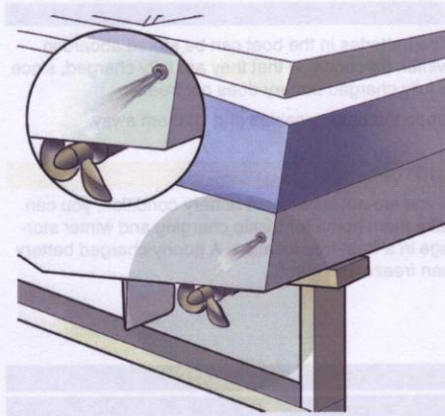

Check that nothing can be splashed from the exhaust outlet. Put the engine control in neutral. Check that there is nothing close to the propeller.

Start the engine and let it idle until the bucket is empty, or circulate the mixture for a few minutes.

WARNING!

Working with an engine which is operating is a safety hazard. Watch out for rotating components and hot surfaces.

Stop the engine at once when the bucket is empty.

IMPORTANT!

The impeller in the sea water pump will be damaged if it runs without water.

For environmental reasons, the mixture should always be collected from the exhaust outlet, and it should be run through several times. The mixture does not need to be drained. If any other type of conservation preparation is used, which does not have frost protection, this must be drained to stop the engine being destroyed by frost.

Clean the engine bay and underneath the engine to remove the cause of dirt and unnecessary noise.
Check the finish of the engine and equipment.
Cooled surfaces should be cleaned and painted with touch-up paint to prevent corrosion attack. Use Volvo Pentacolor primer and varnish.

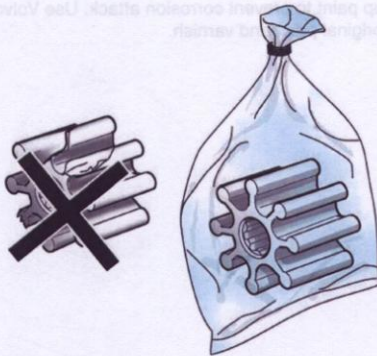

Impeller (all engines)

Remove the cover from the seawater pump.

Take the impeller out, inspect the impeller and if it is undamaged, put it in a plastic bag for winter storage in a cool place.

Inspect the inside of the pump housing and clean the cover if needed, before it is installed temporarily.

Vacuum valve

If the engine is equipped with a vacuum valve, this must be taken to pieces and cleaned. Please refer to the "Vacuum valve" section.

Electrical system

Cables

The cables in the electrical system have many connectors, where damp can find its way in and cause electrical problems because of corrosion. To avoid this, these places should be protected with water-dispersant spray.

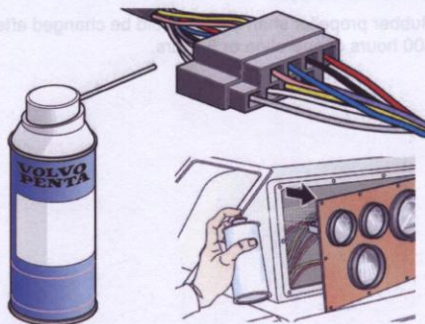

There are many connections underneath the instrument panel. The rest of the boat's electrical system is connected to a distribution box which also needs to be protected.

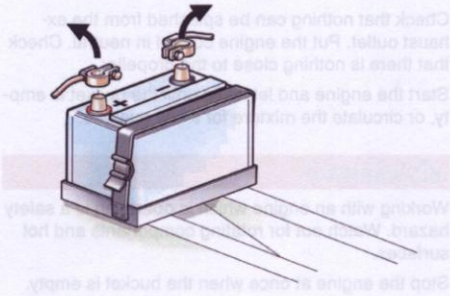

Batteries

The batteries in the boat can be stored aboard in winter, on condition that they are fully charged, since a fully charged battery does not freeze.

Undo the battery cables and lift them away.

NOTE!

If you are not sure about battery condition, you can take them home for trickle charging and winter storage in a frost-free location. A poorly charged battery can freeze and burst.

Other matters

Engine bay

Clean the engine bay and underneath the engine, to remove the causes of odor and unnecessary moisture.

Check the finish of the engine and equipment. Chafed patches should be cleaned and painted with touch-up paint to prevent corrosion attack. Use Volvo Penta original paint and varnish.

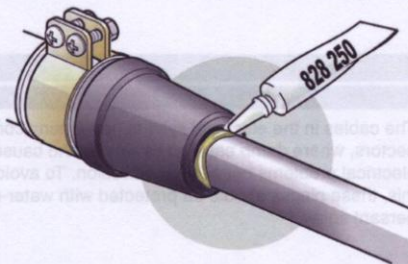

Propeller shaft seal

If the engine has a reversing gear and has a rubber propeller shaft seal, about 1 ml of water-resistant grease, Volvo Penta part number 828250, should be forced into the seal.

Rubber propeller shaft seals should be changed after 500 hours of operation or 5 years.

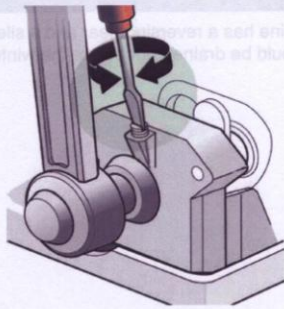

Controls

Lift off the engine control cover.

Grease the lever bearings and the control cable ends. Spray water-repellent spray into the control cables.

Check their function.

There is a friction screw under the cover on most engine controls. If the friction in the lever needs to be adjusted, tighten it to increase friction or loosen it to reduce friction. Put the cover back.

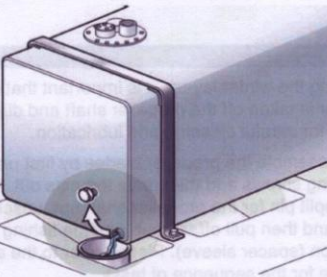

Fuel tank

Open the bottom tap on the fuel tank and drain off any water and contamination.

Fill the fuel tank completely, to avoid condensation.

NOTE!

But check first that there are no special rules at the storage site, about the amount of fuel on board.

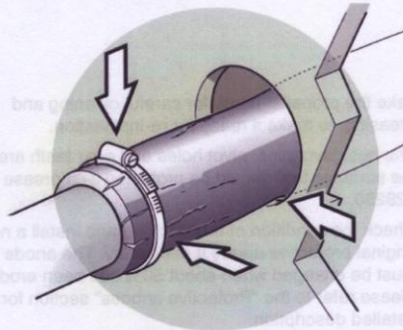

Rubber components

Check that all rubber components feel soft and are free from cracks. Change if necessary.

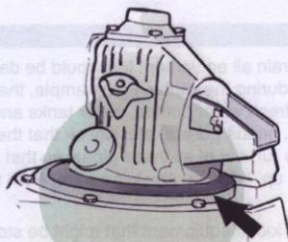

If the boat is equipped with an 110 or 120 S-drive, the rubber bellows between the drive and the bed should be checked carefully. The boat's buoyancy depends on this bellows remaining undamaged. It should be changed every 5 years. Ask an authorized workshop to do this task if you feel at all unsure about it. Instructions for doing this task are included in the rubber bellows kit. The actual change should be done in the spring since the external rubber bellows should be bonded when the weather is warm and dry.

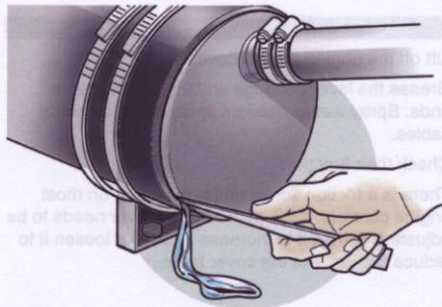

The exhaust system

If the engine has a reversing gear and a silencer, any water should be drained out before the winter starts.

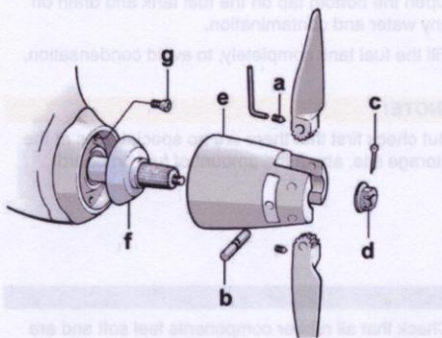

Folding propeller

During the winter lay-up, it is important that the propeller is taken off the propeller shaft and disassembled for careful cleaning and lubrication.

Disassemble the propeller blades by first undoing the locking screws and then drive the pins out. Remove the split pin for the propeller shaft nut, unscrew the nut and then pull off the hub and the fishing line protection (spacer sleeve). Please refer to the adjacent figure for the sequence of tasks.

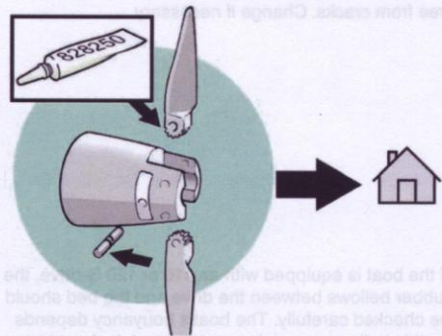

Take the propeller home for careful cleaning and greasing, to make it ready for re-installation.

The hub, pivot pins, pivot holes and gear teeth are the surfaces that should be protected with grease no. 828250.

Check the condition of the zinc ring and install a new, original protective anode if necessary. The anode must be changed when about 50% has been eroded. Please refer to the "Protective anodes" section for a detailed description.

Other equipment

Review and drain all equipment that could be damaged by frost during the winter. For example, the bilge pumps, fresh water pumps, water tanks and water heaters, heads (toilets) etc. Check that the water really does run out of all these pipes, so that they will not freeze up. Wipe up any bilge water from the keelson.

Take home all loose equipment that might be stolen. Check that the hull supports are steady, and that the winter cover is securely fastened. The boat is now prepared for winter storage, but take a look at it at regular intervals, to check that wind or snow have not disturbed the covers.

Removing conservation preparations

The protective anodes are supposed to protect the light metal components of the S-drive from galvanic corrosion. The requirement for protection is effected by the fact that the anodes are in good contact with the hull housing and that not more than 50% of the hull

if corrosion damage occurs on the drive, there can be several causes. Anti-fouling paint that contains copper can cause severe damage. An anode in poor condition or in poor contact with the drive, or an electrical system that causes stray currents can also cause damage. Some external factors can also lead to the corrosion process, such as the salt content of the water.

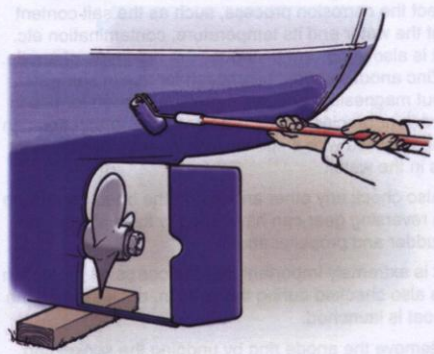

Remove the anodes and by rubbing the surface. Check the anode plugs on the folding propeller. If more than 50% of them has been eroded, they must be changed.

Carefully scrape the mating surface on the drive clean. There must not be any paint on this surface. Install a new protective anode and tighten it evenly to ensure good metallic contact. The anode must not be painted under any circumstances.

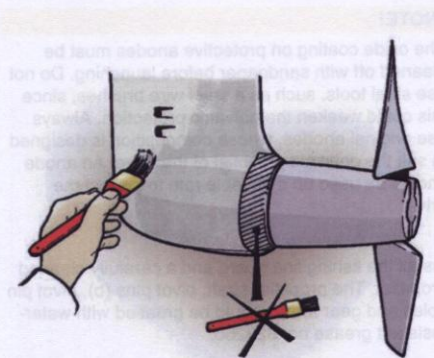

The coating of protective anodes must be done with care. The anodes must be in good contact with the hull housing and that not more than 50% of the hull housing is eroded.

Removing covers

Take off the winter covers and let the boat air properly for a few warm days.

It is now time to varnish or oil wood components, mend any damage to the hull and re-touch or re-paint the entire bottom. If the rubber bellows for the S-drive needed to be changed, this should be done now, before the bottom is re-painted.

Boat hull

All anti-fouling paints are poisonous and thus more or less damaging for the marine environment. Avoid these preparations. Most countries have legislation which regulates the use of anti-fouling hull paints.

Always comply with these restrictions. In some cases, their use is completely banned on pleasure boats in fresh water etc. If it is easy to take the boat out of the water, we recommend that only a Teflon coating should be used, combined with mechanical cleaning a few times during the season.

If you have a larger boat, this can be impractical. If the boat is in waters that encourage marine growth, it might be necessary to use anti-fouling paint anyway. In this case, use a pure copper-based anti-fouling paint that contains copper thiocyanate, **not copper oxide**.

IMPORTANT!

Leave a 10 mm un-painted area round the S-drive.

Tin based paints (TBT paints) must not be used.

Find out about the legislation applicable to the area where the boat is used.

S - drive

Before the drive is painted with anti-fouling paint, any paint damage must be repaired. Sand metal surfaces lightly with 120 grit emery paper, and use finer paper on painted surfaces. Wash with cellulose thinners or an equivalent product. Any pores must be filled and sanded. Paint with Volvo Penta original primer plus a top coat. Give the paints time to harden. Then apply at least two coats of Volvo Penta anti-fouling **primer**. Leave to dry. Then apply at least two coats of Volvo Penta anti-fouling paint.

IMPORTANT!

The protective anodes on the drive must neither be painted nor Teflon coated. This also applies to bronze or stainless steel propellers.

*Teflon is a registered trademark of the Du Pont Corporation.

Protective anodes

The protective anodes are supposed to protect the light metal components of the S-drive from galvanic corrosion. The requirement for protection to be effective is that the anode ring is in good contact with the drive housing and that not more than 50% of the ring has been eroded.

If corrosion damage occurs on the drive, there can be several causes. Anti-fouling paint that contains copper can cause severe damage. An anode in poor condition or in poor contact with the drive, or an electrical system that causes stray currents can also cause damage. Some external factors can also affect the corrosion process, such as the salt content of the water and its temperature, contamination etc. It is also important to choose the right type of anode. Zinc anodes should be chosen for use in salt water, but magnesium anodes should be chosen for use in fresh or brackish water. The corrosion protection can be checked with a special instrument when the boat is in the water.

Also check any other anodes on the boat. Boats with a reversing gear can have anodes fixed around the rudder and propeller shaft.

It is extremely important that the corrosion protection is also checked during the season, not just when the boat is launched.

Remove the anode ring by undoing the socket cap screws. Check the anode plugs on the folding propeller. If more than 50% of them has been eroded, they must be changed.

Carefully scrape the mating surface on the drive clean. There must not be any paint on this surface. Install a new protective anode ring and tighten it securely, to ensure good metallic contact. The anode must not be painted under any circumstances.

NOTE!

The oxide coating on protective anodes must be cleaned off with sandpaper before launching. Do not use steel tools, such as a steel wire brushes, since this could weaken the galvanic protection. Always use original anodes, whose composition is designed to suit the galvanic potential of the drive. An anode should be used up a suitable rate to protect the drive!

Install the fishing line guard and a carefully cleaned propeller. The propeller shaft, pivot pins (b), pivot pin holes and gear teeth should be greased with water-resistant grease no. 828250.

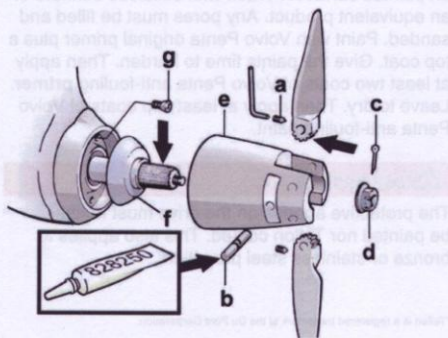
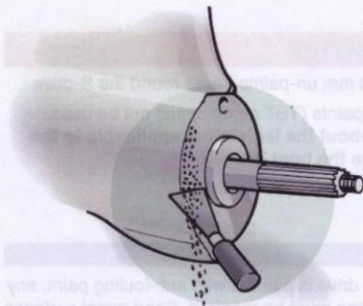
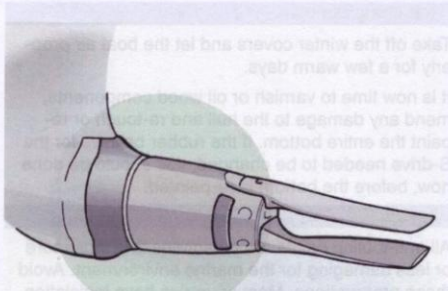



Engine and transmission

If the engine was filled with Volvo Penta engine oil during conservation, the lubrication system is ready for use. On the other hand, if conservation oil has been put in, this must be drained out and Volvo Penta oil put in. The oil filter must also be changed. Check the oil level in the engine and reversing gear or S-drive before launching.

Cooling system

If the cooling system was conserved with a water-glycol mixture before the winter, this fluid must now be flushed out. Organize a collection vessel under the exhaust outlet. Take the thermostat out and re-install the cover temporarily. Connect a fresh water hose to the suction side of the sea water pump and flush the system through.

NOTE!

Re-use the mixture next season, or hand it to a recycling depot. For environmental reasons, it must not be discharged into the water or tipped out on land.

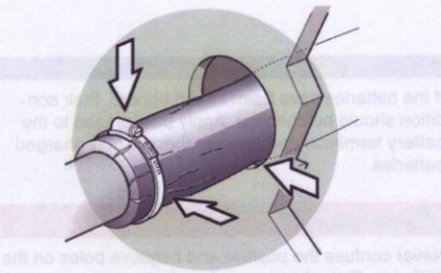

Check all hoses in the cooling system for cracks and other damage that might affect the boat's buoyancy. After this, all hose clamps should be inspected and re-tightened. The hose clamps should be stainless. Be careful to re-align any hoses that might be exposed to chafing. Open the sea cock or tap on the S - drive.



Re-install the impeller. Put grease on the shaft and press it in through the seal rings while turning it, from the pump impeller side. Press the impeller in, and on early models fix the impeller with the flange screw. Install the lid with a new seal.

Press the impeller in, and on early models fix the impeller with the flange screw. Install the lid with a new seal.

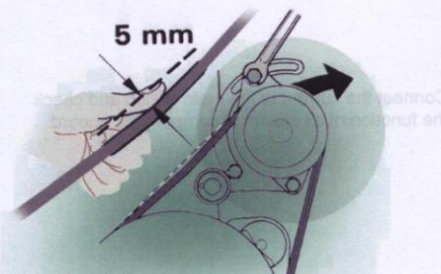

Vee belt

Check and adjust belt tension as necessary. Please refer to the "Alternator" section.

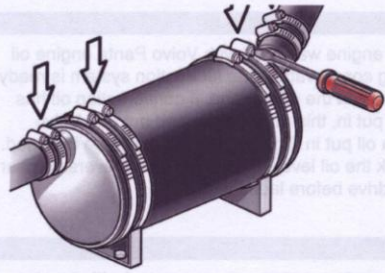

Exhaust system

Check all exhaust hoses for condition and possible damage. Re-tighten all hose clamps.

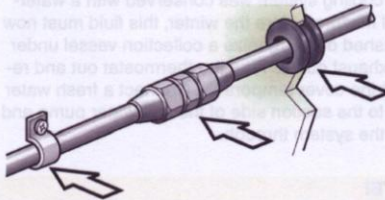

Fuel system

Check all fuel pipes for wear, aging and clamping. Change any components that show the slightest signs of damage since they could fail when subjected to heat and vibration during operation.

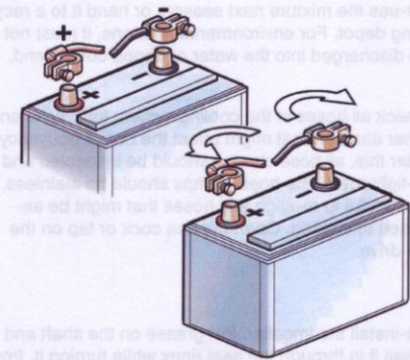

Electrical system

If the batteries have been stored aboard, their condition should be checked. Apply pole grease to the battery terminals and connect them to fully charged batteries.

WARNING!

Never confuse the positive and negative poles on the batteries. Risk of arcing and explosion.

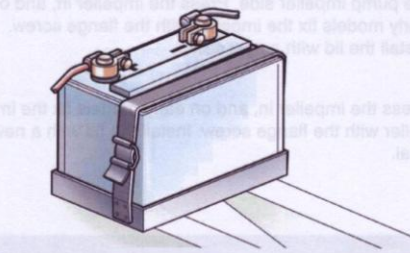

Check that the batteries are securely fixed.



Connect the current to the main switch and check the function of all electrical components aboard.

Launching

Check list

The points below can be used as a check list before launching.

Please supplement the list with your own points, that apply to YOUR boat and engine. Check that:

- all levels are correct
- all drain taps are closed
- all hoses are connected
- all hose clamps are tightened
- the batteries are fully charged
- the batteries are securely fastened
- all electrical components function
- the tools have been taken away from the engine
- the sea cock is open
- the seawater pump impeller is installed
- belt tension is correct
- the boat is "ready" below the waterline
- the fuel taps are open
- the propeller is correctly installed and fixed

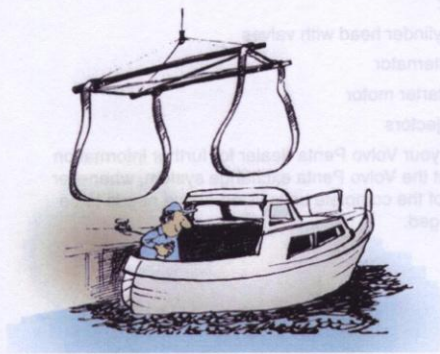

Launching

Check immediately after launching that no leakage occurs.

Propeller shaft seal, inboard engines

If the engine has a reversing gear with a rubber propeller shaft seal, it must be vented immediately after launching.

Press the seal down as shown in the figure, so that water seeps out. Then press about 1 ml of water-resistant grease, Volvo Penta part no. 828250 into the seal.

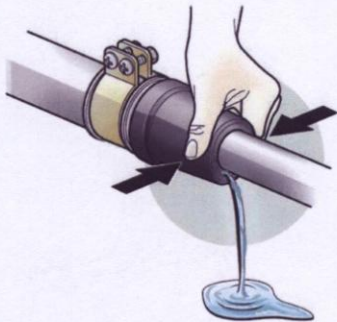

Test driving

Start up and check that no leakage occurs around the engine and its equipment.

Go for a trial run, where all functions are tested. Check the instruments, observe noise and any vibration.

After the trial run, check that no leakage occurs.

Volvo Penta's exchange system

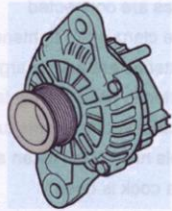
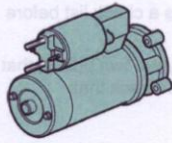

Components encompassed by the exchange system are complete units such as the alternator and starter motor. If you hand your damaged starter motor in, you can choose to buy a renovated starter motor at a lower price than buying a new one.

The fully renovated starter motor is renovated to new condition, as all other complete units included in the exchange system, to the same specifications and data as a new factory unit. You have the same warranty and security as if you had chosen a new factory unit.

The products available for the MD5-MD17 are as follows:

- Cylinder head with valves
- Alternator
- Starter motor
- Injectors

Visit your Volvo Penta dealer for further information about the Volvo Penta exchange system, whenever one of the complete units listed above needs to be changed.

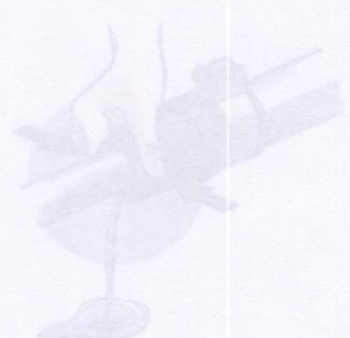
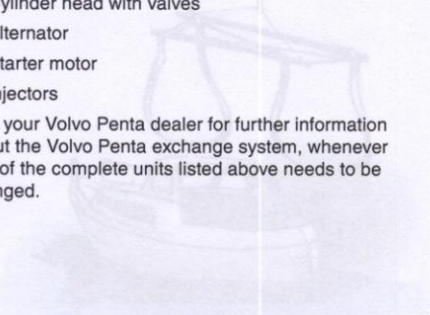

Accessories

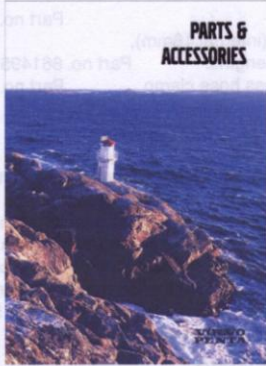

General

Volvo Penta has a wide range of accessories for both the engine and the boat, plus maintenance components and chemical products for care and maintenance. Volvo Penta Accessories have been subjected to function and service life testing, and comply with Volvo Penta's quality and safety requirements. New products are developed all the time, so the product range is renewed and changed every year. Technical developments, especially in the field of electronics, have made it possible to develop accessories that were not commercially available, or whose price was unattainable, when the MD5-MD17 were manufactured. Accessories with whose help you can now increase both safety and comfort aboard. Investments which can also raise the boat's value. You can find the product range in our "Spares and Accessories" catalogue which is published annually, and can be obtained from your Volvo Penta dealer. The Accessories catalogue is also available on the Internet; www.volvopenta.com

Please visit the QL, Quality Line web site as well. These are marine accessories from Volvo Penta at; www.qlmarine.com.

The following accessories are only a selection, please refer to our accessories catalogue and consult your Volvo Penta dealer if you are not sure about what might suit your engine or your boat.

Engine accessories

Fresh water cooling for MD11-MD17

Fresh water cooling is recommended in very salty, corrosive or contaminated water, to avoid excessive deposits in the engine's cooling system. Fresh water cooling also makes it possible to install a take-off for a hot water heater. Before installation, the cooling system should be carefully inspected and the cooling ducts cleaned. Installation of fresh water cooling is recommended in conjunction with engine renovation, since it also considerably increases the service life of the engine.

NOTE!

A fresh water cooled engine will run at a higher operating temperature, which will often lead to loosening of residual rust, dirt and deposits after some time of operation. Consult your Volvo Penta dealer when the cooling system is cleaned. Efficient cleaning often requires corrosive chemicals, which must be handled carefully.



Seawater filter for MD5, MD7, MD11, MD17

An efficient water filter intended for separate installation in the boat, above the waterline. The filter kit consists of a filter, that can be cleaned, and a cover. The filter effectively removes contamination from the sea water, and contributes to increasing engine life. Coolant connections for hose (internal dia. 16 mm) and installation screws with washers. The filter should be connected to the suction side of the cooling system.

Filter Part no. 829711
 Hose, (internal 16mm),
 uncut lengths. Part no. 861495
 Stainless hose clamp Part no. 961666



Water trap

Separate water trap intended to be installed between the fuel tank and the fuel pump, but not on the engine. There is a drain tap underneath the filter bowl, to drain water and contamination. A water trap counteracts fuel-related faults, where condensed water and contamination damage the injection pump and injectors. Supplied with unions for 5/16" and 3/8" swaged copper pipe.

Part no. 833972



Combined fuel filter / water trap

Intended to be installed between the fuel tank and the fuel pump. It functions as both a water trap and secondary filter. It is easy to drain any water and contamination from the metal bowl, through a drain tap. The filter is supplied without unions for the fuel pipes. Please consult your Volvo Penta for suitable unions for your engine.

Complies with the EU requirements in RCD 94/25/EC.
 Part no. 877766



Charge splitter

The charge splitter makes it possible to charge two independent battery circuits at the same time. The starter battery always stays charged, even if a lot of current has been taken from the rest of the electrical system in the boat. Since the MD5-MD17 engines were manufactured, the range of marine accessories, often requiring electric current, has increased considerably. The demands on the boat's electrical system increases when we connect further loads, such as navigation equipment. Consult your Volvo Penta for advice and a review of the boat's electrical system. The electrical system is a safety-related system, so any changes must be done in a professional manner, with components intended for marine use.

Part no. 873120

Oils, paints and other accessories



Volvo Penta has developed a range of suitable and thoroughly-tested products, which make maintenance work easier. When you have used these products, your engine and equipment have received the best possible care.

All Volvo Penta's products, engines, drives, accessories, paint and oils are subjected to stringent testing and are the focus of constant development so that they always comply with new, stricter environmental requirements. We do not spare any resources in making the environmental impact of our products as small as possible. This is one of the reasons that you should always choose Volvo Penta Original Spares.

A list of these maintenance products is shown below, which have not been mentioned earlier in this book. Please refer to the Volvo Penta Accessory catalogue as well.

Volvo Penta Engine Oils



Volvo Penta engine oils have the composition needed to withstand a marine environment, that makes special demands on oils. The additives in the oil bind up soot, carbon, metal particles and they neutralize acids. Water is also bound, and the oil has a preserving effect that makes it suitable to use as a winter oil during the lay-off period, on condition that the oil is changed when the boat is laid up or conserved.

Volvo Penta oil is a CD oil that complies with the requirements in the VDS specification, and its viscosity is SAE 15W/40.

The engine oil is also used for the reversing gear and the S-drive.

The oil is available in 1-liter and 4-liter containers.

Coolant



The fresh water system (optional) is the internal cooling system of the engine, which ensures that the engine works at the correct temperature.

It is a closed system and must therefore always be filled with a mixture of at least 40% concentrated coolant and 60% water, to offer protection from interior corrosion, cavitation and frost bursting.

We recommend that you use "Volvo Penta Coolant, Ready Mixed", or "Volvo Penta Coolant" (concentrated) mixed with pure water. This grade of coolant is the only one that is developed for and approved by Volvo Penta.

The coolant should contain a good grade of ethylene glycol and a suitable chemical formula for full engine protection. The use of only an anti-corrosion preparation is not permissible for use in Volvo Penta engines. Never use water by itself as the coolant.



Universal oil

In the harsh environment that the boat and its equipment are subjected to, the electrical system in the boat is the part that probably suffers most from malfunctions. The reason is frequently corrosion in terminals, with consequent voltage drop or open circuits.

Volvo Penta universal oil in a spray can offers excellent protection against corrosion, since it is water-repellent.

The spray can contains 200 ml.

Part no. 1161657



Water resistant grease

When propellers are removed, the propeller shafts should be protected by a thin layer of water-resistant grease. This also makes propellers easier to pull off next time they are to be removed.

Volvo Penta water-resistant grease is available in a practical plastic tube that holds 27 g.

This grease is also used for inboard installations, for the rubber seal on the propeller shaft. The grease can also be used for lubricating the control components.

Part no. 828250



Paints

It is important that damage to surface paint is mended as soon as possible, to prevent the engine and drive/reversing gear from corrosion. Original paints are available in both spray and bulk packages. Please refer to the accessory catalogue for part numbers.

When anti-fouling paint is chosen, it is important to comply with the laws and local recommendations in force.



On-board kit

An on-board kit increases safety at sea. Ask your Volvo Penta dealer to put together a kit specially for your engine and transmission. The kit should contain an impeller, drive belt, fuses, hose clamps etc. Also, do not forget critical components for boat equipment on board, such as fuses.



Tool kit

A well-equipped tool kit is essential on board. Volvo Penta's tool kits are chosen for service work, and contain an oil drain pump etc., in addition to high quality tools.

Packed in a practical plastic box which is easy to stow away.

Part no. 858282

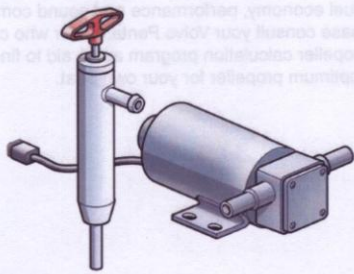

Oil drain pump

When it is time to change the oil, it is practical to use a mechanical or electric oil drain pump. In most cases, it is impossible to drain the oil due to the small spaces available.

Hoses are included with the mechanical oil pump.

Part no. 875117

The electric oil drain pump is very easy to use. Oil is drained very rapidly with the impeller pump.

The oil drain pump is complete with hoses and electric cables for connection to the boat battery.

Part no. 843114

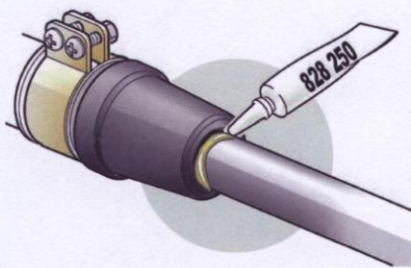

Stuffing box

Cast stuffing box for efficient sealing and good lubrication. Volvo Penta's stuffing boxes require minimal maintenance work - lubrication every 200 hours of operation, or once a year. Supplied complete with installation tools and a tube of grease.

25 mm shaft Part no. 828254

30 mm shaft Part no. 828422

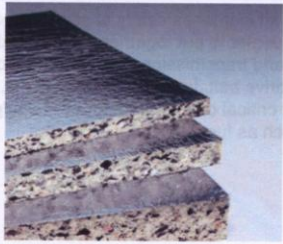

Noise insulation

Noise insulation often needs to be checked on older boats. It can both be damaged, but developments in materials have also lead to new, efficient materials which are easy to install. Your life in your boat will be more pleasant with a well-insulated engine room. Volvo Penta's QL sound insulation efficiently absorbs engine noise. The insulation matting has been developed for the noise frequencies and noise levels in the marine environment. Please refer to Volvo Penta's accessory catalogue for specifications and part numbers.

When the sound insulation is reviewed, the engine mounting pads should also be checked. These might need to be checked after many years of service.



Propellers

Volvo Penta has a wide range of propellers, both fixed and folding propellers. If your present propeller is damaged or does not give the boat optimum performance, it might be time to change the propeller. New, efficient three and four blade folding propellers are now available for sailing boats, for both a fixed shaft and S-drive. The size of the propeller must be calculated, based on engine power, gear ratio, boat type and weight. The correct size has a decisive effect on fuel economy, performance and sound comfort. Please consult your Volvo Penta dealer who can use a propeller calculation program as an aid to finding the optimum propeller for your own boat.

